



GILLETTE GENERATORS

LIQUID COOLED NAT. GAS ENGINE GENERATOR SET

60 HZ MODEL

SP-6500

Model	STANDBY 130°C RISE		
	HZ	LPG	N.G.
SP-6500-60 HERTZ	60	420	650



All generator sets are USA prototype built and thoroughly tested. Production models are USA factory built and 100% load tested.



UL2200, UL1446, UL508, UL142, UL498



NFPA 110, 99, 70, 37

All generator sets meet NFPA-110 Level 1, when equipped with the necessary accessories and installed per NFPA standards.



NEC 700, 701, 702, 708



NEMA ICS10, MG1, ICS6, AB1



ANSI C62.41, 27, 59, 32, 480, 40Q, 81U, 360-05



ASCE 7-05 & 7-10

All generator sets meet 180 MPH rating.



EPA 40CFR Part 60, 1048, 1054, 1065, 1068

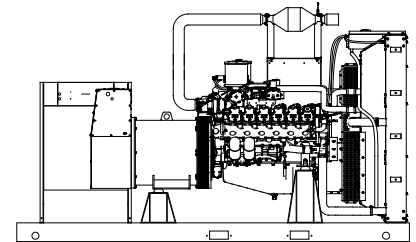

“OPEN” GEN-SET

There is no enclosure, so gen-set must be placed within a weather protected area, un-inhabited by humans or animals, with proper ventilation. Silencer not supplied, as installation requirements are not known. However, this item is available as optional equipment.

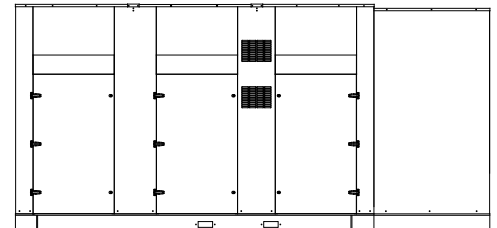

“LEVEL 2” HOUSED GEN-SET

Full aluminum weather protection and superior sound attenuation for specific low noise applications. Critical grade muffler is standard.

GENERATOR RATINGS

GENERATOR MODEL	VOLTAGE		PH	HZ	LIQUID PROPANE GAS FUEL		NATURAL GAS FUEL	
	L-N	L-L			130°C RISE STANDBY RATING		130°C RISE STANDBY RATING	
					KW/KVA	AMP	KW/KVA	AMP
SP-6500-3-2	120	208	3	60	420/525	1458	650/812	2258
SP-6500-3-3	120	240	3	60	420/525	1264	650/812	1957
SP-6500-3-4	277	480	3	60	420/525	632	650/812	978
SP-6500-3-5	127	220	3	60	420/525	1379	650/812	2135
SP-6500-3-16	346	600	3	60	420/525	505	650/812	783

RATINGS: All three phase gen-sets are 12 lead windings, rated at .8 power factor. 130°C “STANDBY RATINGS” are strictly for gen-sets that are used for back-up emergency power to a failed normal utility power source. This standby rating allows varying loads, with no overload capability, for the entire duration of utility power outage. All gen-set power ratings are based on temperature rise measured by resistance method as defined by MIL-STD 705C and IEEE STD 115, METHOD 6.4.4. All generators have class H (180°C) insulation system on both rotor and stator windings. All factory tests and KW/KVA charts shown above are based on 130°C (standby) R/R winding temperature, within a maximum 40°C ambient condition. Generators operated at standby power ratings must not exceed the temperature rise limitation for class H insulation system, as specified in NEMA MG1-22.40. Specifications & ratings are subject to change without prior notice.

APPLICATION AND ENGINEERING DATA FOR MODEL SP-6500-60 HZ

COOLING SYSTEM

Type of System Pressurized, closed recovery
 Coolant PumpPre-lubricated, self-sealing
 Cooling Fan Type (no. of blades) Pusher (10)
 Fan Diameter inches (mm)..... 68" (1727)
 Ambient Capacity of Radiator °F (°C)..... 125 (51.6)
 Engine Jacket Coolant Capacity Gal (L).....23.3 (88.1)
 Radiator Coolant Capacity Gal. (L)39 (148)
 Maximum Restriction of Cooling Air Intake
 and discharge side of radiator in. H₂O (kpa)..... 0.5 (.125)
 Water Pump Flow gpm (L/min).....436 (1650)
 Heat Reject Coolant: Btu/min (kw) 34,074 (599)
 Low Radiator Coolant Level Shutdown.....Standard
 Note: Coolant temp. shut-down switch setting at 230°F (110°C) with 50/50
 (water/antifreeze) mix.

AIR REQUIREMENTS

Combustion Air, cfm (m³/min) 1396 (40)
 Radiator Air Flow cfm (m³/min).....65,100 (1843)
 Heat Rejected to Ambient:
 Engine: kw (btu/min)..... 146 (8310)
 Alternator: kw (btu/min)..... 65 (3696)

EXHAUST SYSTEM

Exhaust Outlet Size..... (2) 6"
 Max. Back Pressure, in. hg (KPA)..... 3.0 (10.2)
 Exhaust Flow, at rated kw: cfm (m³/min)4079 (115)
 Exhaust Temp., at rated kw: °F (°C)1183 (639)
 Engines are EPA certified for Natural Gas.

SOUND LEVELS MEASURED IN dB(A)

	Open Set	Level 2 Encl.
Level 2, Critical Silencer	97.....	86
Level 3, Hospital Silencer.....	92.....	80

Note: Open sets (no enclosure) has (2) optional silencer system choices due to unknown job-site applications. Level 2 enclosure has installed critical silencer with upgrade to hospital silencer. Sound tests are averaged from several test points and taken at 23 ft. (7 m) from source of noise at normal operation.

DERATE GENERATOR FOR ALTITUDE

3% per 1000 ft.(305m) above 3000 ft. (914m) from sea level

DERATE GENERATOR FOR TEMPERATURE

2% per 10°F(5.6°C) above 104°F (40°C)

DIMENSIONS AND WEIGHTS

	Open Set	Level 2 Enclosure
Length in (cm).....	186 (472)	246 (625)
Width in (cm).....	92 (234)	92 (234)
Height in (cm).....	98 (249)	116 (295)
3 Ø Net Weight lbs (kg).....	15950 (7235) ..	18940 (8591)
3 Ø Ship Weight lbs (kg)	16340 (7412) ..	19340 (8772)

DEEP SEA 7420 DIGITAL MICROPROCESSOR CONTROLLER



DEEP SEA 7420

The 7420 controller is an auto start mains (utility) failure module for single gen-set applications. This controller includes a backlit LCD display which continuously displays the status of the engine and generator at all times.

The 7420 controller will also monitor speed, frequency, voltage, current, oil pressure, coolant temp., and fuel levels. These modules have been designed to display warning and shut down status. It also includes: (11) configurable inputs • (8) configurable outputs • voltage monitoring • mains (utility) failure detection

- (250) event logs • configurable timers • automatic shutdown or warning during fault detection • remote start (on load) • engine preheat • advanced metering capability • hour meter • text LCD displays • protected solid state outputs • test buttons for: stop/reset • manual mode • auto mode • lamp test • start button • power monitoring (kWh, kVar, kVAh, kVArh) This controller includes expansion features including RS232, RS484 (using MODBUS-RTU/TCP), direct USB connection with PC, expansion optioned using DSENet for remote annunciation and remote relay interfacing for a distance of up to 3300FT. The controller software is freely downloadable from the internet and allows monitoring with direct USB cable, LAN, or by internet via the built in web interface.

LOW LOAD CONDITIONS: Operation of PSI HD engines at low-load conditions should be limited to no more than one (1) hour per twenty-four (24) hour period. If the application requires extended time at light loads, it is recommended that the engine load be increased to at least 70% of mechanical rating for a minimum of two (2) hours per fifty (50) hours of low-load operation. Piston sealing rings rely on adequate cylinder firing pressure and temperature to seal the combustion chamber and prevent excessive engine oil from entering the power cylinder. Under low loads these rings will not seal properly, resulting in oil being burned in the combustion chamber and carbon deposits on pistons and valves. This mechanism is well-documented in reciprocating engines of all fuel types and is often referred to as "wet-stacking."

STANDARD FEATURES FOR MODEL SP-6500-60 HZ

STANDARD FEATURES

CONTROL PANEL:

Deep Sea 7420 digital microprocessor with logic allows programming in the field. Controller has:

- STOP-MANUAL-AUTO modes and automatic engine shutdowns, signaled by full text LCD indicators:
- Low oil pressure • Engine fail to start
- High engine temp • Engine over speed
- Low Radiator Level • Engine under speed
- Three auxiliary alarms • Over & under voltage
- Battery fail alarm

Also included is tamper-proof engine hour meter

ENGINE:

Full flow oil filter • Air filter • Oil pump • Solenoid type starter motor • Hi-temp radiator • Jacket water pump

- Thermostat • Pusher fan and guard • Exhaust manifold
- 24 VDC battery charging alternator • Flexible exhaust connector • "Isochronous" duty, electronic governor • Secondary dry fuel regulator • Dry fuel lock-off solenoid • Vibration isolators • Closed coolant recovery system with 50/50 water to anti-freeze mixture • flexible oil & radiator drain hose.

AC GENERATOR SYSTEM:

AC generator • Shunt excited • Brushless design • Circuit Breaker installed and wired to gen-set • Direct connection to engine with flex disc • Class H, 180°C insulation • Self ventilated • Drip proof construction • UL Certified

VOLTAGE REGULATOR:

½% Voltage regulation • EMI filter • Under-speed protection • Over-excitation protection • total encapsulation

DC ELECTRICAL SYSTEM:

Battery tray • Battery cables • Battery hold down straps

- 2-stage battery float charger with maintaining & recharging automatic charge stages

WEATHER/SOUND PROOF ALUMINUM HOUSING CORROSION RESISTANT PROTECTION CONSISTING OF:

- 9 Heated and Agitated Wash Stages
- Zinc Phosphate Etching-coating Stage
- Final Baked On Enamel Powder Coat
- 18/8 Stainless Steel Hardware

Design & specifications subject to change without prior notice. Dimensions shown are approximate. Contact Gillette for certified drawings. DO NOT USE DIMENSIONS FOR INSTALLATION PURPOSES.

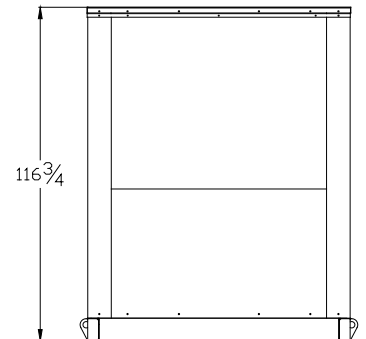
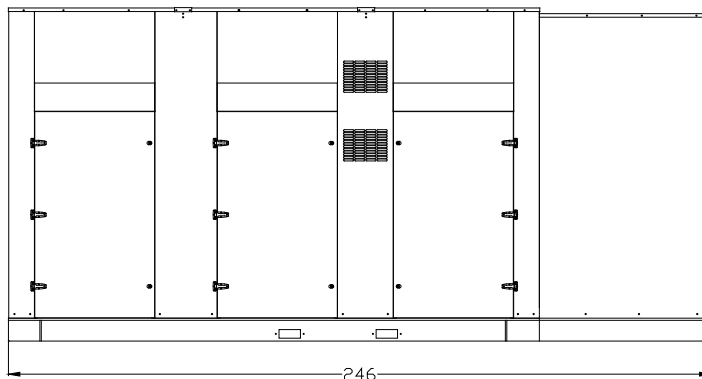
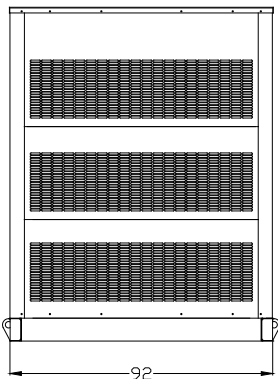
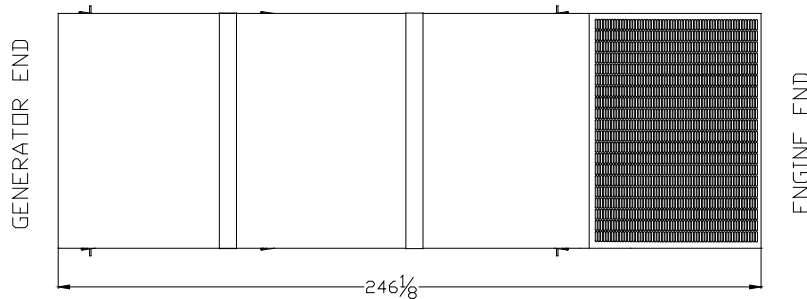

31.8L



HEAVY-DUTY

[Stoic.]
Rev: 1

General Engine Data ⁹											
Type	V-Series				Flywheel housing				SAE No.0		
Number of cylinders	12				Flywheel				SAE No.18		
Aspiration	Charged Cooled Forced Induction				Dry Weight (Fan to Flywheel)		lb	kg	7344	3331	
Firing Order	1 - 8 - 5 - 10 - 3 - 7 - 6 - 11 - 2 - 9 - 4 - 12				Wet Weight (Fan to Flywheel)		lb	kg	7788	3533	
Rotation Viewed from Flywheel	Counter Clockwise				CG From Rear Face of Block		in	mm	37.0	941	
Bore	in	mm	5.906	150	CG Above Crank Centerline		in	mm	0	0	
Stroke	in	mm	5.906	150	Oil Specification		SAE 15W-40 Low Ash Gas engine oil (.25-.5% by wt), API CD/CF or higher				
Displacement	in ³	L	1941	31.8	Engine Oil Capacity ⁸						
Compression Ratio	10.5 : 1				Min		qts	L	95	90	
Exhaust Manifold Type	Water Cooled				Max		qts	L	129	122	
Turbo Exhaust Outlet Pipe Size	in	mm	3.5	89	ECU Oil Pressure Warning ⁶		psi	kPa	57	393	
Catalyst Inlet Size	in	mm	5	127	ECU Oil Pressure Shut Down ⁶		psi	kPa	47	324	
Maximum Allowable Exhaust Back Pressure	in-Hg	kPa	3.0	10.2	Oil Pressure at 1000 rpm (Idle)						
Maximum EPR Rated Pressure	psi	kPa	1.0	6.9	Min		psi	kPa	82	569	
Maximum Operating pressure to EPR	in-H ₂ O	kPa	11.0	2.7	Max		psi	kPa	74	512	
Minimum Operating pressure to EPR	in-H ₂ O	kPa	7.0	1.7	Max Allowable Oil Temperature		°F	°C	250	121	
Minimum Gas Supply Pipe Size ⁵	in	mm	3	76	Coolant Capacity (Engine only)		gal	L	23.3	88.1	
Maximum Pressure Drop Across CAC	psi	kPa	1	6.9	Standard Thermostat Range						
Max Allowable Intake Restriction					Normal Operation Temperature ⁹		°F	°C	176	80	
Clean Air Filter	in-H ₂ O	kPa	5	1.24	Full Open Temperature ⁷		°F	°C	198	92	
Dirty Air Filter	in-H ₂ O	kPa	15	3.73	ECU Coolant Temp Warning		°F	°C	203	95	
Spark Plug Part Number	Bosch R6 6857				ECU Coolant Temp Shutdown		°F	°C	208	98	
Standard Spark Plug Gap ¹⁰	in	mm	0.012	0.3	50°C Ambient Capable ¹¹		Pass				
Spark Plug Coil - Primary Resistance	Ohms		0.59Ω ± 10%		Max External Coolant Friction Head		psi	kPa	7.25	50	
Battery Voltage	Volts		24		CAC Rise Above Ambient Specified		F	C	15	9	
Starter Motor Power	HP	kW	15.7	11.7							
Performance Data 60Hz ^{3,5}											
Nominal Engine Speed	RPM		1800		Water Pump Speed		RPM		3705		
Mean Piston Speed	ft/min	m/s	1772	9.0	Engine Coolant Flow		gal/min	L/min	361	1368	
RPM Range (Min-Max) ISO 8528-5 G1	RPM		1778 - 1823		Cooling Fan Power ¹¹		HP	kW	62.8	47	
Charging Alternator Voltage	Volts		28		Cooling Fan Speed		RPM		1050		
Charging Alternator Current	Amps		55		Cooling Fan Air Flow ¹¹		SCFM	m ³ /min	65100	1843	
NG 60hz		Load		100%		75%		50%		25%	
Stand-By Power Rating ^{1,2,3,4} Per ISO 3046	HP	kW	966	720	724	540	483	360	243	181	
MEP (@ rated Load on NG)	psi	bar	219	15.1	164	11.3	109	7.5	55	3.8	
Fuel Consumption ^{3,4,7}	lb/hr	kg/hr	341	155	263	119	192	87	122	55	
BSFC	lb/(hp-hr)	g/(kW-hr)	0.370	225	0.383	233	0.415	253	0.508	309	
Turbine Outlet Temperature	°F	°C	1183	639	1111	600	1055	568	1006	541	
Exhaust Mass Flow (entire engine)	lb/hr	kg/hr	6396	2901	4907	2226	3578	1623	2226	1010	
Exhaust Flow at Turbine Outlet Conditions	ACFM	m ³ /min	4079	115	3126	89	2263	64	1390	39	
Air Induction System ⁵											
Combustion Air required (entire engine)	lb/hr	kg/hr	6055	2746	4644	2106	3385	1536	2104	954	
Combustion Air Volume Required (entire engine)	ACFM	m ³ /min	1320	37	1012	29	738	21	458	13	
Compressor Outlet Temperature ²	°F	°C	269	132	252	122	207	97	140	60	
Thermal Balance ⁵											
Total Fuel	BTU/min	kW	123393	2170	95872	1686	69190	1217	43019	756	
Mechanical Power	BTU/min	kW	40946	720	30709	540	20473	360	10295	181	
Heat Rejected to Cooling Water at Rated Load	BTU/min	kW	34074	599	26768	471	21379	376	15114	266	
Heat Rejection CAC at Rated Power	BTU/min	kW	4169	73	2661	47	1435	25	475	8	
Heat Rejection to Exhaust (LHV to 150C)	BTU/min	kW	27496	483	19649	346	13115	231	7370	130	
Engine Radiated Heat	BTU/min	kW	16710	294	16085	283	12788	225	9765	172	

¹ Standby and overload ratings based on ISO 3046 gross flywheel power.

² Technical data based on ISO 3046-1 standards of 77°F(25°C), absolute pressure 14.5Psia(100kPa) and 30% relative humidity.

³ Production tolerances in engines and installed components can account for power variations of ± 5%. Altitude, temperature and excessive exhaust and intake restrictions should be applied to power calculations.

⁴ All fuel and thermal calculations unless otherwise noted are done at ISO 3046 rated load using LHV for NG of 48.17 MJ/kg.

⁵ All values in the following section are provided for informational purpose only and are non-binding.

⁶ >1400RPM.

⁷ See PSI HD Technical Spec. 56300002 - Fuel Specification.

⁸ Standard Sump Capacity

⁹ ± 2 degrees Celsius.

¹⁰ ± 0.002" or 0.05mm.

¹¹ At 0.5 in-H₂O of Package Restriction at STP.

31.8L



HEAVY-DUTY

[Stoic.]
Rev: 1

General Engine Data ¹											
Type	V-Series				Flywheel housing				SAE No.0		
Number of cylinders	12				Flywheel				SAE No.18		
Aspiration	Charged Cooled Forced Induction				Dry Weight (Fan to Flywheel)		lb	kg	7344	3331	
Firing Order	1 - 8 - 5 - 10 - 3 - 7 - 6 - 11 - 2 - 9 - 4 - 12				Wet Weight (Fan to Flywheel)		lb	kg	7788	3533	
Rotation Viewed from Flywheel	Counter Clockwise				CG From Rear Face of Block		in	mm	37.0	941	
Bore	in	mm	5.906	150	CG Above Crank Centerline		in	mm	0	0	
Stroke	in	mm	5.906	150	Oil Specification		SAE 15W-40 Low Ash Gas engine oil (.25-.5% by wt), API CD/CF or higher				
Displacement	in ³	L	1941	31.8	Engine Oil Capacity ⁸						
Compression Ratio	10.5 : 1				Min		qts	L	95	90	
Exhaust Manifold Type	Water Cooled				Max		qts	L	129	122	
Turbo Exhaust Outlet Pipe Size	in	mm	3.5	89	ECU Oil Pressure Warning ⁶		psi	kPa	57	393	
Catalyst Inlet Size	in	mm	5	127	ECU Oil Pressure Shut Down ⁶		psi	kPa	47	324	
Maximum Allowable Exhaust Back Pressure	in-Hg	kPa	3.0	10.2	Oil Pressure at 1000 rpm (Idle)						
Maximum EPR Rated Pressure	psi	kPa	1.0	6.9	Min		psi	kPa	82	569	
Maximum Operating pressure to EPR	in-H ₂ O	kPa	11.0	2.7	Max		psi	kPa	74	512	
Minimum Operating pressure to EPR	in-H ₂ O	kPa	7.0	1.7	Max Allowable Oil Temperature		°F	°C	250	121	
Minimum Gas Supply Pipe Size ⁵	in	mm	3	76	Coolant Capacity (Engine only)		gal	L	23.3	88.1	
Maximum Pressure Drop Across CAC	psi	kPa	1	6.9	Standard Thermostat Range						
Max Allowable Intake Restriction					Normal Operation Temperature ⁹		°F	°C	176	80	
Clean Air Filter	in-H ₂ O	kPa	5	1.24	Full Open Temperature ⁷		°F	°C	198	92	
Dirty Air Filter	in-H ₂ O	kPa	15	3.73	ECU Coolant Temp Warning		°F	°C	203	95	
Spark Plug Part Number	Bosch R6 6857				ECU Coolant Temp Shutdown		°F	°C	208	98	
Standard Spark Plug Gap ¹⁰	in	mm	0.012	0.3	50°C Ambient Capable ¹¹		Pass				
Spark Plug Coil - Primary Resistance	Ohms		0.59Ω ± 10%		Max External Coolant Friction Head		psi	kPa	7.25	50	
Battery Voltage	Volts		24		CAC Rise Above Ambient Specified		F	C	15	9	
Starter Motor Power	HP	kW	15.7	11.7							
Performance Data 50Hz ^{3,5}											
Nominal Engine Speed	RPM		1500		Water Pump Speed		RPM		3088		
Mean Piston Speed	ft/min	m/s	1476	7.5	Engine Coolant Flow		gal/min	L/min	297	1126	
RPM Range (Min-Max) ISO 8528-5 G1	RPM		1477 - 1519		Cooling Fan Power ¹¹		HP	kW	36	27	
Charging Alternator Voltage	Volts		28		Cooling Fan Speed		RPM		875		
Charging Alternator Current	Amps		53		Cooling Fan Air Flow ¹¹		SCFM	m ³ /min	54200	1535	
NG 50hz		Load		100%		75%		50%		25%	
Stand-By Power Rating ^{1,2,3,4} Per ISO 3046	HP	kW	805	600	603	450	402	300	202	151	
MEP (@ rated Load on NG)	psi	bar	219	15.1	164	11.3	109	7.5	55	3.8	
Fuel Consumption ^{3,4,7}	lb/hr	kg/hr	290	132	227	103	164	74	101	46	
BSFC	lb/(hp-hr)	g/(kW-hr)	0.363	221	0.373	227	0.408	248	0.502	306	
Turbine Outlet Temperature	°F	°C	1078	581	1032	556	990	532	915	491	
Exhaust Mass Flow (entire engine)	lb/hr	kg/hr	4861	2205	3816	1731	2771	1257	1732	786	
Exhaust Flow at Turbine Outlet Conditions	ACFM	m ³ /min	3183	90	2477	70	1772	50	1071	30	
Air Induction System ⁵											
Combustion Air required (entire engine)	lb/hr	kg/hr	4571	2073	3589	1628	2607	1183	1631	740	
Combustion Air Volume Required (entire engine)	ACFM	m ³ /min	996	28	782	22	568	16	355	10	
Compressor Outlet Temperature ²	°F	°C	254	124	223	106	172	78	124	51	
Thermal Balance ⁵											
Total Fuel	BTU/min	kW	99707	1753	78048	1372	56389	992	34855	613	
Mechanical Power	BTU/min	kW	34121	600	25591	450	17061	300	8580	151	
Heat Rejected to Cooling Water at Rated Load	BTU/min	kW	27127	477	23202	408	18642	328	13478	237	
Heat Rejection CAC at Rated Power	BTU/min	kW	3151	55	2041	36	902	16	247	4	
Heat Rejection to Exhaust (LHV to 150C)	BTU/min	kW	18671	328	13756	242	9269	163	5094	90	
Engine Radiated Heat	BTU/min	kW	16637	293	13458	237	10516	185	7456	131	

¹ Standby and overload ratings based on ISO 3046 gross flywheel power.

² Technical data based on ISO 3046-1 standards of 77°F(25°C), absolute pressure 14.5Psia(100kPa) and 30% relative humidity.

³ Production tolerances in engines and installed components can account for power variations of ± 5%. Altitude, temperature and excessive exhaust and intake restrictions should be applied to power calculations.

⁴ All fuel and thermal calculations unless otherwise noted are done at ISO 3046 rated load using LHV for NG of 48.17 MJ/kg.

⁵ All values in the following section are provided for informational purpose only and are non-binding.

⁶ >1400RPM.

⁷ See PSI HD Technical Spec. 56300002 - Fuel Specification.

⁸ Standard Sump Capacity.

⁹ ± 2 degrees Celsius.

¹⁰ ± 0.002" or 0.05mm.

¹¹ At 0.5 in-H₂O of Package Restriction at STP.

31.8L



HEAVY-DUTY

[Stoic.]
Rev: 1

General Engine Data ¹											
Type	V-Series				Flywheel housing				SAE No.0		
Number of cylinders	12				Flywheel				SAE No.18		
Aspiration	Charged Cooled Forced Induction				Dry Weight (Fan to Flywheel)		lb	kg	7344	3331	
Firing Order	1 - 8 - 5 - 10 - 3 - 7 - 6 - 11 - 2 - 9 - 4 - 12				Wet Weight (Fan to Flywheel)		lb	kg	7788	3533	
Rotation Viewed from Flywheel	Counter Clockwise				CG From Rear Face of Block		in	mm	37.0	941	
Bore	in	mm	5.906	150	CG Above Crank Centerline		in	mm	0	0	
Stroke	in	mm	5.906	150	Oil Specification		SAE 15W-40 Low Ash Gas engine oil (.25-.5% by wt), API CD/CF or higher				
Displacement	in ³	L	1941	31.8	Engine Oil Capacity ⁸		Min	qts	L	95 90	
Compression Ratio	10.5 : 1				Max		qts	L	129	122	
Exhaust Manifold Type	Water Cooled				ECU Oil Pressure Warning ⁶		psi	kPa	57	393	
Turbo Exhaust Outlet Pipe Size	in	mm	3.5	89	ECU Oil Pressure Shut Down ⁶		psi	kPa	47	324	
Catalyst Inlet Size	in	mm	5	127	Oil Pressure at 1000 rpm (Idle)		Min	psi	kPa	82 569	
Maximum Allowable Exhaust Back Pressure	in-Hg	kPa	3.0	10.2	Max		psi	kPa	74	512	
Maximum EPR Rated Pressure	psi	kPa	1.0	6.9	Max Allowable Oil Temperature		°F	°C	250	121	
Maximum Operating pressure to EPR	in-H ₂ O	kPa	11.0	2.7	Coolant Capacity (Engine only)		gal	L	23.3	88.1	
Minimum Operating pressure to EPR	in-H ₂ O	kPa	7.0	1.7	Standard Thermostat Range		Normal Operation Temperature ⁹ °F °C 176 80				
Minimum Gas Supply Pipe Size ⁵	in	mm	3	76	Full Open Temperature ⁷		°F	°C	198	92	
Maximum Pressure Drop Across CAC	psi	kPa	1	6.9	ECU Coolant Temp Warning		°F	°C	203	95	
Max Allowable Intake Restriction					ECU Coolant Temp Shutdown		°F	°C	208	98	
Clean Air Filter	in-H ₂ O	kPa	5	1.24	50°C Ambient Capable ¹¹		Pass				
Dirty Air Filter	in-H ₂ O	kPa	15	3.73	Max External Coolant Friction Head		psi	kPa	7.25	50	
Spark Plug Part Number	Bosch R6 6857				CAC Rise Above Ambient Specified		F	C	15	9	
Standard Spark Plug Gap ¹⁰	in	mm	0.012	0.3							
Spark Plug Coil - Primary Resistance	Ohms		0.59Ω ± 10%								
Battery Voltage	Volts		24								
Starter Motor Power	HP	kW	15.7	11.7							
Performance Data 60Hz ^{3,5}											
Nominal Engine Speed	RPM		1800			Water Pump Speed		RPM 3705			
Mean Piston Speed	ft/min	m/s	1772	9.0	Engine Coolant Flow		gal/min	L/min	361	1368	
RPM Range (Min-Max) ISO 8528-5 G1	RPM		1778 - 1823			Cooling Fan Power ¹¹		HP	kW	62.8	47
Charging Alternator Voltage	Volts		28			Cooling Fan Speed		RPM 1050			
Charging Alternator Current	Amps		55			Cooling Fan Air Flow ¹¹		SCFM	m ³ /min	65100	1843
LPG 60hz		Load		100%		75%		50%		25%	
Stand-By Power Rating ^{1,2,3,4} Per ISO 3046	HP	kW	637	475	478	356	318	238	160	119	
MEP (@ rated Load on NG)	psi	bar	144	10.0	108	7.5	72	5.0	36	2.5	
Fuel Consumption ^{3,4,7}	lb/hr	kg/hr	293	133	217	98	154	70	105	48	
BSFC	lb/(hp-hr)	g/(kW-hr)	0.458	279	0.454	276	0.485	295	0.629	383	
Turbine Outlet Temperature	°F	°C	1208	653	1117	603	1057	569	973	523	
Exhaust Mass Flow (entire engine)	lb/hr	kg/hr	4844	2197	3596	1631	2558	1160	1735	787	
Exhaust Flow at Turbine Outlet Conditions	ACFM	m ³ /min	3439	97	2493	71	1748	49	1123	32	
Air Induction System ⁵											
Combustion Air required (entire engine)	lb/hr	kg/hr	4551	2064	3379	1533	2404	1090	1630	739	
Combustion Air Volume Required (entire engine)	ACFM	m ³ /min	992	28	736	21	524	15	355	10	
Compressor Outlet Temperature ²	°F	°C	255	124	220	104	164	73	123	50	
Thermal Balance ⁵											
Total Fuel	BTU/min	kW	97288	1711	72203	1270	51298	902	34824	612	
Mechanical Power	BTU/min	kW	27013	475	20260	356	13506	238	6792	119	
Heat Rejected to Cooling Water at Rated Load	BTU/min	kW	30994	545	25757	453	20306	357	14388	253	
Heat Rejection CAC at Rated Power	BTU/min	kW	3127	55	1868	33	770	14	240	4	
Heat Rejection to Exhaust (LHV to 150C)	BTU/min	kW	22299	392	14605	257	9642	170	5609	99	
Engine Radiated Heat	BTU/min	kW	13855	244	9713	171	7073	124	7796	137	

¹ Standby and overload ratings based on ISO 3046 gross flywheel power.

² Technical data based on ISO 3046-1 standards of 77°F(25°C), absolute pressure 14.5Psia(100kPa) and 30% relative humidity.

³ Production tolerances in engines and installed components can account for power variations of ± 5%. Altitude, temperature and excessive exhaust and intake restrictions should be applied to power calculations.

⁴ All fuel and thermal calculations unless otherwise noted are done at ISO 3046 rated load using LHV for LPG 46.38 MJ/kg.

⁵ All values in the following section are provided for informational purpose only and are non-binding.

⁶ >1400RPM.

⁷ See PSI HD Technical Spec. 56300002 - Fuel Specification.

⁸ Standard Sump Capacity.

⁹ ± 2 degrees Celsius.

¹⁰ ± 0.002" or 0.05mm.

¹¹ At 0.5 in-H₂O of Package Restriction at STP.

31.8L



HEAVY-DUTY

[Stoic.]
Rev: 1

General Engine Data ⁹											
Type	V-Series				Flywheel housing				SAE No.0		
Number of cylinders	12				Flywheel				SAE No.18		
Aspiration	Charged Cooled Forced Induction				Dry Weight (Fan to Flywheel)		lb	kg	7344	3331	
Firing Order	1 - 8 - 5 - 10 - 3 - 7 - 6 - 11 - 2 - 9 - 4 - 12				Wet Weight (Fan to Flywheel)		lb	kg	7788	3533	
Rotation Viewed from Flywheel	Counter Clockwise				CG From Rear Face of Block		in	mm	37.0	941	
Bore	in	mm	5.906	150	CG Above Crank Centerline		in	mm	0	0	
Stroke	in	mm	5.906	150	Oil Specification		SAE 15W-40 Low Ash Gas engine oil (.25-.5% by wt), API CD/CF or higher				
Displacement	in ³	L	1941	31.8	Engine Oil Capacity ⁸						
Compression Ratio	10.5 : 1				Min		qts	L	95	90	
Exhaust Manifold Type	Water Cooled				Max		qts	L	129	122	
Turbo Exhaust Outlet Pipe Size	in	mm	3.5	89	ECU Oil Pressure Warning ⁶		psi	kPa	57	393	
Catalyst Inlet Size	in	mm	5	127	ECU Oil Pressure Shut Down ⁶		psi	kPa	47	324	
Maximum Allowable Exhaust Back Pressure	in-Hg	kPa	3.0	10.2	Oil Pressure at 1000 rpm (Idle)						
Maximum EPR Rated Pressure	psi	kPa	1.0	6.9	Min		psi	kPa	82	569	
Maximum Operating pressure to EPR	in-H ₂ O	kPa	11.0	2.7	Max		psi	kPa	74	512	
Minimum Operating pressure to EPR	in-H ₂ O	kPa	7.0	1.7	Max Allowable Oil Temperature		°F	°C	250	121	
Minimum Gas Supply Pipe Size ⁵	in	mm	3	76	Coolant Capacity (Engine only)		gal	L	23.3	88.1	
Maximum Pressure Drop Across CAC	psi	kPa	1	6.9	Standard Thermostat Range						
Max Allowable Intake Restriction					Normal Operation Temperature ⁹		°F	°C	176	80	
Clean Air Filter	in-H ₂ O	kPa	5	1.24	Full Open Temperature ⁷		°F	°C	198	92	
Dirty Air Filter	in-H ₂ O	kPa	15	3.73	ECU Coolant Temp Warning		°F	°C	203	95	
Spark Plug Part Number	Bosch R6 6857				ECU Coolant Temp Shutdown		°F	°C	208	98	
Standard Spark Plug Gap ¹⁰	in	mm	0.012	0.3	50°C Ambient Capable ¹¹		Pass				
Spark Plug Coil - Primary Resistance	Ohms		0.59Ω ± 10%		Max External Coolant Friction Head		psi	kPa	7.25	50	
Battery Voltage	Volts		24		CAC Rise Above Ambient Specified		F	C	15	9	
Starter Motor Power	HP	kW	15.7	11.7							
Performance Data 50Hz ^{3,5}											
Nominal Engine Speed	RPM		1500		Water Pump Speed		RPM		3088		
Mean Piston Speed	ft/min	m/s	1476	7.5	Engine Coolant Flow		gal/min	L/min	297	1125.6	
RPM Range (Min-Max) ISO 8528-5 G1	RPM		1477 - 1519		Cooling Fan Power ¹¹		HP	kW	36.4	27	
Charging Alternator Voltage	Volts		28		Cooling Fan Speed		RPM		875		
Charging Alternator Current	Amps		53		Cooling Fan Air Flow ¹¹		SCFM	m ³ /min	54200	1535	
LPG 50hz		Load		100%		75%		50%		25%	
Stand-By Power Rating ^{1,2,3,4} Per ISO 3046	HP	kW	543	405	407	304	272	203	137	102	
MEP (@ rated Load on NG)	psi	bar	148	10.2	111	7.6	74	5.1	37	2.6	
Fuel Consumption ^{3,4,7}	lb/hr	kg/hr	604	274	571	259	631	286	849	385	
BSFC	lb/(hp-hr)	g/(kW-hr)	0.428	260	0.445	271	0.437	266	0.599	364	
Turbine Outlet Temperature	°F	°C	1168	631	1077	581	1022	550	947	508	
Exhaust Mass Flow (entire engine)	lb/hr	kg/hr	4406	1998	3287	1491	2599	1179	2202	999	
Exhaust Flow at Turbine Outlet Conditions	ACFM	m ³ /min	2913	82	2017	57	1426	40	943	27	
Air Induction System ⁵											
Combustion Air required (entire engine)	lb/hr	kg/hr	3802	1725	2716	1232	1969	893	1352	613	
Combustion Air Volume Required (entire engine)	ACFM	m ³ /min	829	23	592	17	429	12	295	8	
Compressor Outlet Temperature ²	°F	°C	246	119	185	85	144	62	113	45	
Thermal Balance ⁵											
Total Fuel	BTU/min	kW	81417	1432	58071	1021	42143	741	28738	505	
Mechanical Power	BTU/min	kW	23032	405	17274	304	11516	203	5791	102	
Heat Rejected to Cooling Water at Rated Load	BTU/min	kW	26302	462	20356	358	16728	294	12536	220	
Heat Rejection CAC at Rated Power	BTU/min	kW	2486	44	1115	20	486	9	145	3	
Heat Rejection to Exhaust (LHV to 150C)	BTU/min	kW	17788	313	11078	195	7540	133	4416	78	
Engine Radiated Heat	BTU/min	kW	11809	208	8248	145	5873	103	5850	103	

¹ Standby and overload ratings based on ISO 3046 gross flywheel power.

² Technical data based on ISO 3046-1 standards of 77°F(25°C), absolute pressure 14.5Psia(100kPa) and 30% relative humidity.

³ Production tolerances in engines and installed components can account for power variations of ± 5%. Altitude, temperature and excessive exhaust and intake restrictions should be applied to power calculations.

⁴ All fuel and thermal calculations unless otherwise noted are done at ISO 3046 rated load using LHV for LPG 46.38 MJ/kg.

⁵ All values in the following section are provided for informational purpose only and are non-binding.

⁶ >1400RPM.

⁷ See PSI HD Technical Spec. 56300002 - Fuel Specification.

⁸ Standard Sump Capacity.

⁹ ± 2 degrees Celsius.

¹⁰ ± 0.002" or 0.05mm.

¹¹ At 0.5 in-H₂O of Package Restriction at STP

STAMFORD®

HCI634G - Winding 311 and 312

Technical  Data Sheet

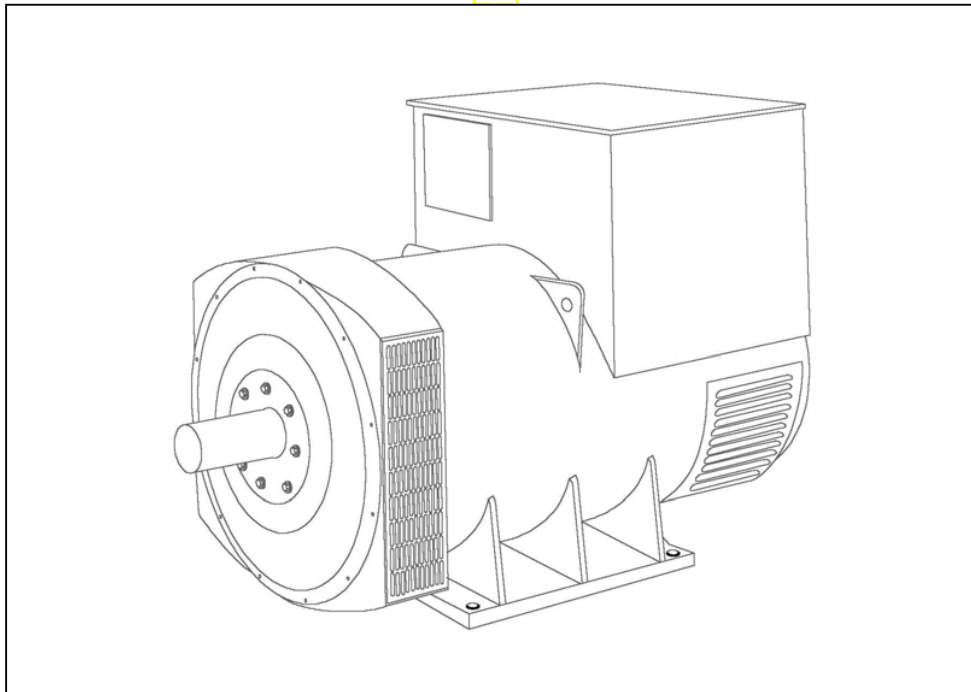

**SPECIFICATIONS & OPTIONS
WINDING 311 and 312****STANDARDS**

Stamford industrial generators meet the requirements of BS EN 60034 and the relevant section of other international standards such as BS5000, VDE 0530, NEMA MG1-32, IEC34, CSA C22.2-100, AS1359.

Other standards and certifications can be considered on request.

VOLTAGE REGULATORS**MX321 AVR - STANDARD**

This sophisticated Automatic Voltage Regulator (AVR) is incorporated into the Stamford Permanent Magnet Generator (PMG) system and is fitted as standard to generators of this type.

The PMG provides power via the AVR to the main exciter, giving a source of constant excitation power independent of generator output. The main exciter output is then fed to the main rotor, through a full wave bridge, protected by a surge suppressor. The AVR has in-built protection against sustained over-excitation, caused by internal or external faults. This de-excites the machine after a minimum of 5 seconds.

Over voltage protection is built-in and short circuit current level adjustments is an optional facility.

WINDINGS & ELECTRICAL PERFORMANCE

All generator stators are wound to 2/3 pitch. This eliminates triplen (3rd, 9th, 15th ...) harmonics on the voltage waveform and is found to be the optimum design for trouble-free supply of non-linear loads. The 2/3 pitch design avoids excessive neutral currents sometimes seen with higher winding pitches, when in parallel with the mains. A fully connected damper winding reduces oscillations during paralleling. This winding, with the 2/3 pitch and carefully selected pole and tooth designs, ensures very low waveform distortion.

TERMINALS & TERMINAL BOX

Standard generators feature a main stator with either 6 ends (Winding 312) or 12 ends (Winding 311) brought out to the terminals, which are mounted on the frame at the non-drive end of the generator. A sheet steel terminal box contains the AVR and provides ample space for the customers' wiring and gland arrangements. It has removable panels for easy access.

SHAFT & KEYS

All generator rotors are dynamically balanced to better than BS6861:Part 1 Grade 2.5 for minimum vibration in operation. Two bearing generators are balanced with a half key.

INSULATION/IMPREGNATION

The insulation system is class 'H'.

All wound components are impregnated with materials and processes designed specifically to provide the high build required for static windings and the high mechanical strength required for rotating components.

QUALITY ASSURANCE

Generators are manufactured using production procedures having a quality assurance level to BS EN ISO 9001.

The stated voltage regulation may not be maintained in the presence of certain radio transmitted signals. Any change in performance will fall within the limits of Criteria 'B' of EN 61000-6-2:2001. At no time will the steady-state voltage regulation exceed 2%.

DE RATES

All values tabulated on page 8 are subject to the following reductions

5% when air inlet filters are fitted.

10% when IP44 Filters are fitted.

3% for every 500 metres by which the operating altitude exceeds 1000 metres above mean sea level.

3% for every 5°C by which the operational ambient temperature exceeds 40°C.

Note: Requirement for operating in an ambient exceeding 60°C must be referred to the factory.

NB Continuous development of our products entitles us to change specification details without notice, therefore they must not be regarded as binding.

Front cover drawing typical of product range.

APPROVED DOCUMENT

WINDING 311 and 312

CONTROL SYSTEM	SEPARATELY EXCITED BY P.M.G.		
A.V.R.	MX321		
VOLTAGE REGULATION	± 0.5 %	With 4% ENGINE GOVERNING	
SUSTAINED SHORT CIRCUIT	REFER TO SHORT CIRCUIT DECREMENT CURVES (page 7)		

INSULATION SYSTEM	CLASS H
PROTECTION	IP23
RATED POWER FACTOR	0.8
STATOR WINDING	DOUBLE LAYER LAP
WINDING PITCH	TWO THIRDS
WINDING LEADS	6 (Wdg 312) or 12 (Wdg 311)
STATOR WDG. RESISTANCE	0.003 Ohms PER PHASE AT 22°C STAR CONNECTED
ROTOR WDG. RESISTANCE	1.75 Ohms at 22°C
EXCITER STATOR RESISTANCE	17 Ohms at 22°C
EXCITER ROTOR RESISTANCE	0.079 Ohms PER PHASE AT 22°C
R.F.I. SUPPRESSION	BS EN 61000-6-2 & BS EN 61000-6-4, VDE 0875G, VDE 0875N. refer to factory for others
WAVEFORM DISTORTION	NO LOAD < 1.5% NON-DISTORTING BALANCED LINEAR LOAD < 5.0%
MAXIMUM OVERSPEED	2250 Rev/Min
BEARING DRIVE END	BALL. 6224 (ISO)
BEARING NON-DRIVE END	BALL. 6317 (ISO)

	1 BEARING	2 BEARING
WEIGHT COMP. GENERATOR	1965 kg	1989 kg
WEIGHT WOUND STATOR	934 kg	934 kg
WEIGHT WOUND ROTOR	814 kg	766 kg
WR ² INERTIA	18.3482 kgm ²	17.8009 kgm ²
SHIPPING WEIGHTS in a crate	2023kg	2029kg
PACKING CRATE SIZE	183 x 92 x 140(cm)	183 x 92 x 140(cm)

	50 Hz	60 Hz
TELEPHONE INTERFERENCE	THF<2%	TIF<50

	1.614 m ³ /sec 3420 cfm				1.961 m ³ /sec 4156 cfm			
VOLTAGE STAR	380/220	400/231	415/240	440/254	416/240	440/254	460/266	480/277
VOLTAGE PARALLEL STAR (*)	190/110	200/115	208/120	220/127	208/120	220/127	230/133	240/138
VOLTAGE DELTA	220	230	240	254	240	254	266	277
kVA BASE RATING FOR REACTANCE VALUES	800	800	800	800	875	925	963	1000
X _d DIR. AXIS SYNCHRONOUS	3.14	2.83	2.63	2.34	3.53	3.34	3.18	3.03
X' _d DIR. AXIS TRANSIENT	0.25	0.23	0.21	0.19	0.28	0.26	0.25	0.24
X'' _d DIR. AXIS SUBTRANSIENT	0.18	0.16	0.15	0.13	0.21	0.20	0.19	0.18
X _q QUAD. AXIS REACTANCE	1.88	1.70	1.58	1.40	2.10	1.98	1.89	1.80
X' _q QUAD. AXIS SUBTRANSIENT	0.21	0.19	0.18	0.16	0.24	0.23	0.22	0.21
X _L LEAKAGE REACTANCE	0.10	0.09	0.08	0.07	0.12	0.11	0.10	0.10
X ₂ NEGATIVE SEQUENCE	0.22	0.20	0.19	0.17	0.24	0.23	0.22	0.21
X ₀ ZERO SEQUENCE	0.03	0.03	0.03	0.02	0.03	0.03	0.03	0.03

REACTANCES ARE SATURATED

VALUES ARE PER UNIT AT RATING AND VOLTAGE INDICATED

T' _d TRANSIENT TIME CONST.	0.185
T'' _d SUB-TRANSTIME CONST.	0.025
T' _{do} O.C. FIELD TIME CONST.	2.35
T _a ARMATURE TIME CONST.	0.04
SHORT CIRCUIT RATIO	1/X _d

(*) Parallel Star connection only available with Wdg 311

**50
Hz**

HCI634G
WINDING 311 and 312

STAMFORD

THREE PHASE EFFICIENCY CURVES

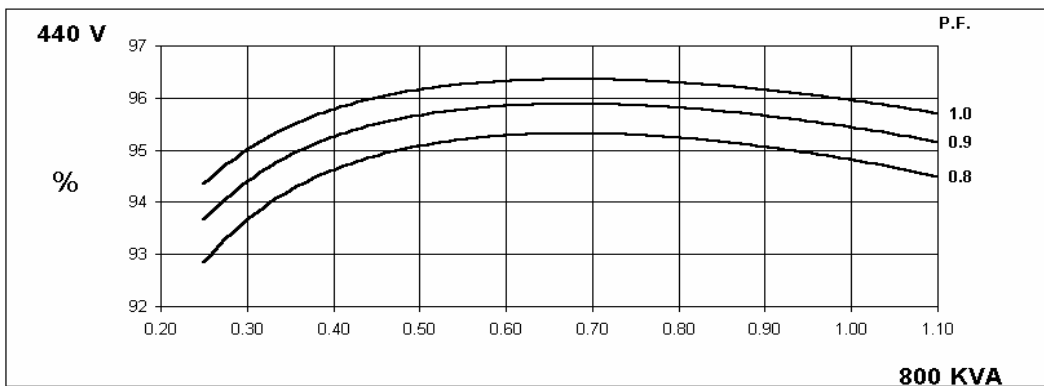
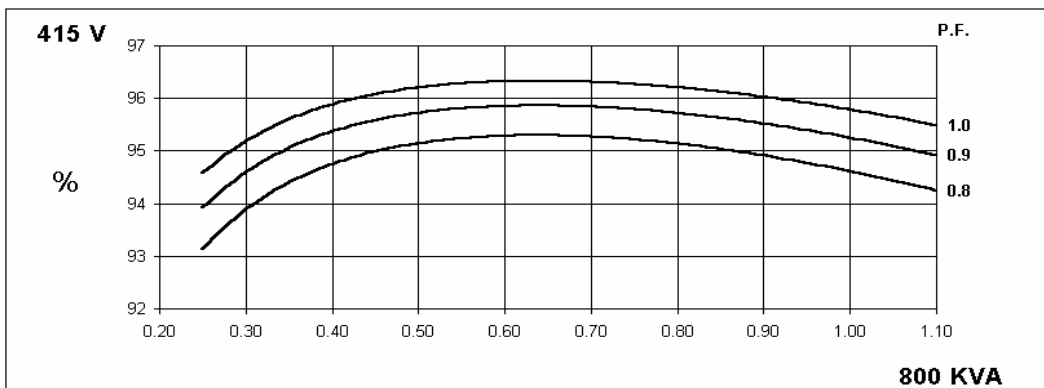
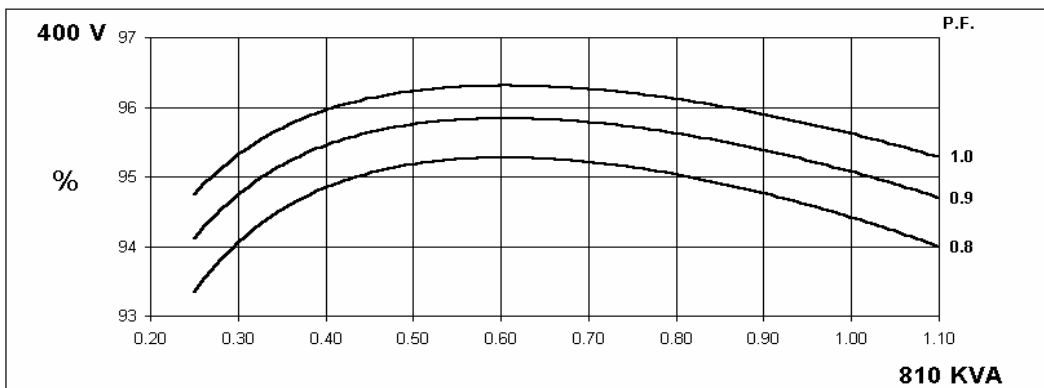
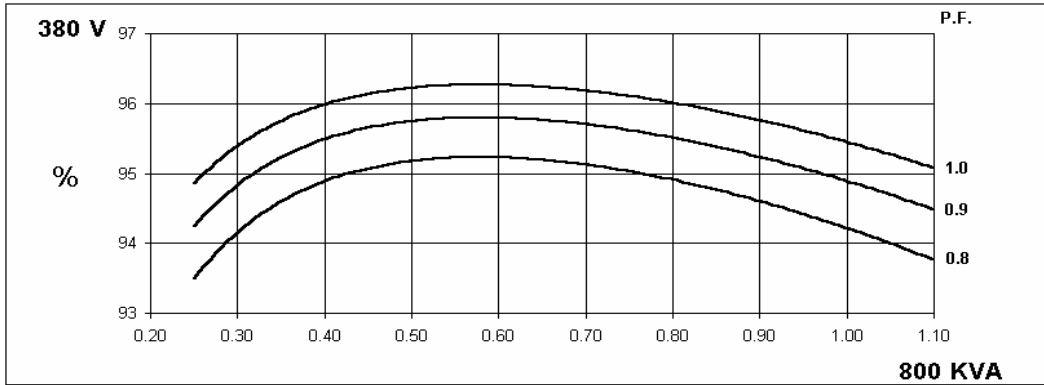

**60
Hz**

HCI634G
WINDING 311 and 312

STAMFORD

THREE PHASE EFFICIENCY CURVES

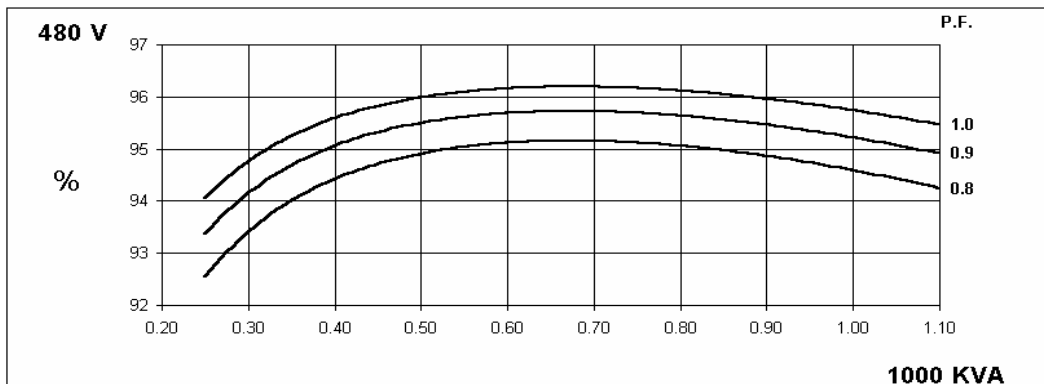
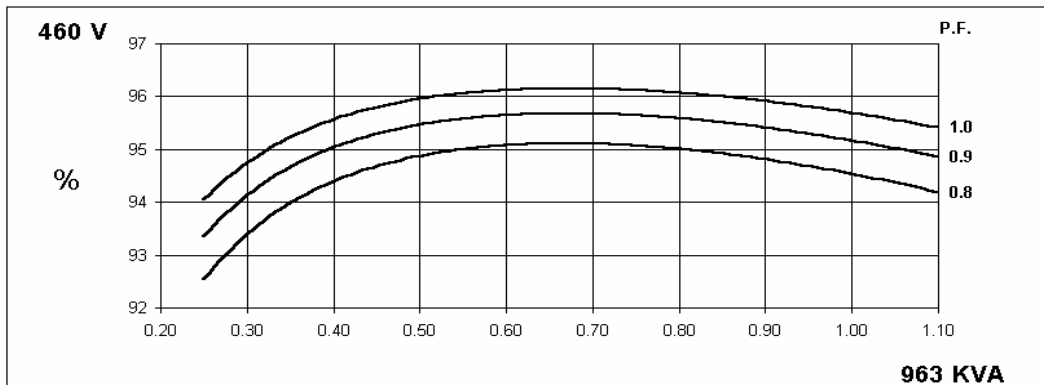
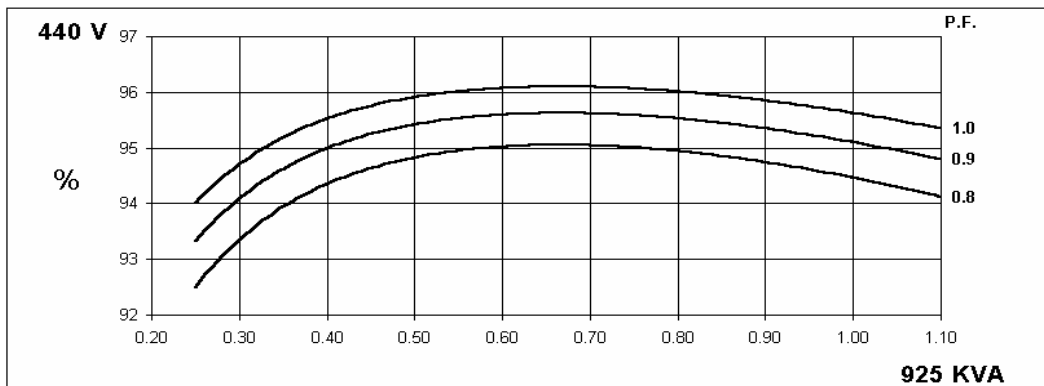
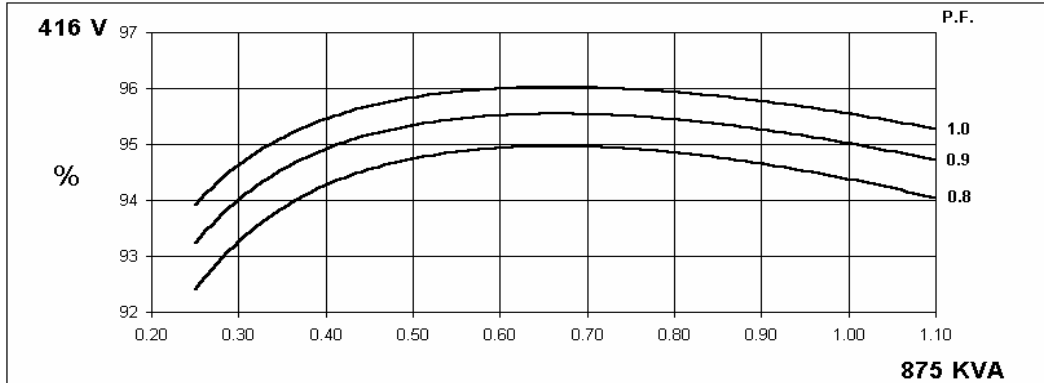

WINDING 311 and 312

Locked Rotor Motor Starting Curve

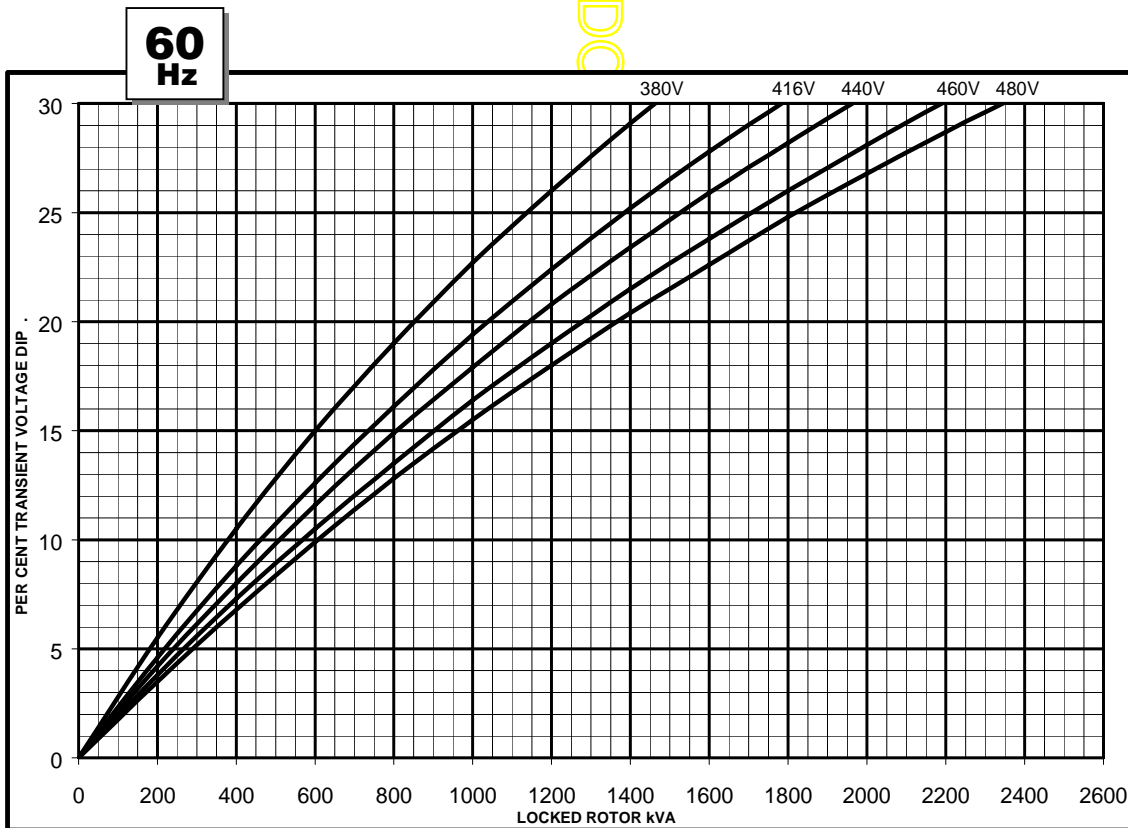
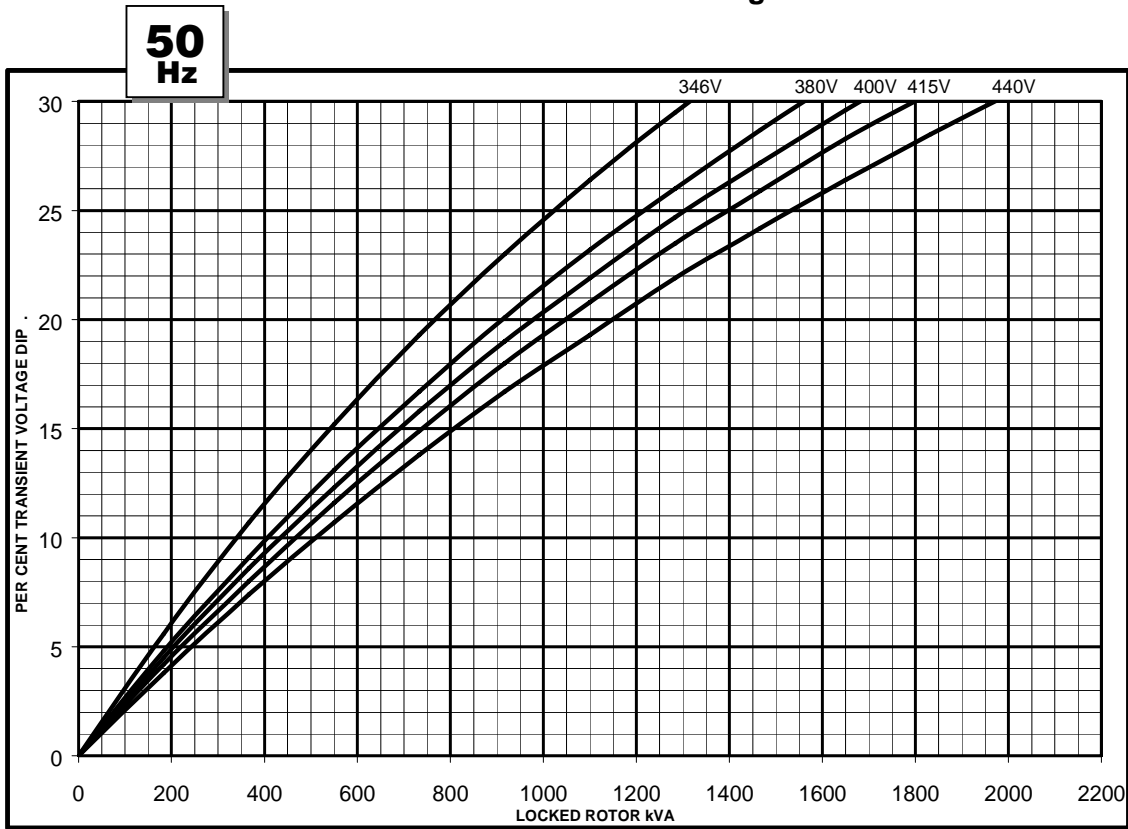

WINDING 311 and 312

**Three-phase Short Circuit Decrement Curve. No-load Excitation at Rated Speed
Based on star (wye) connection.**

**50
Hz**

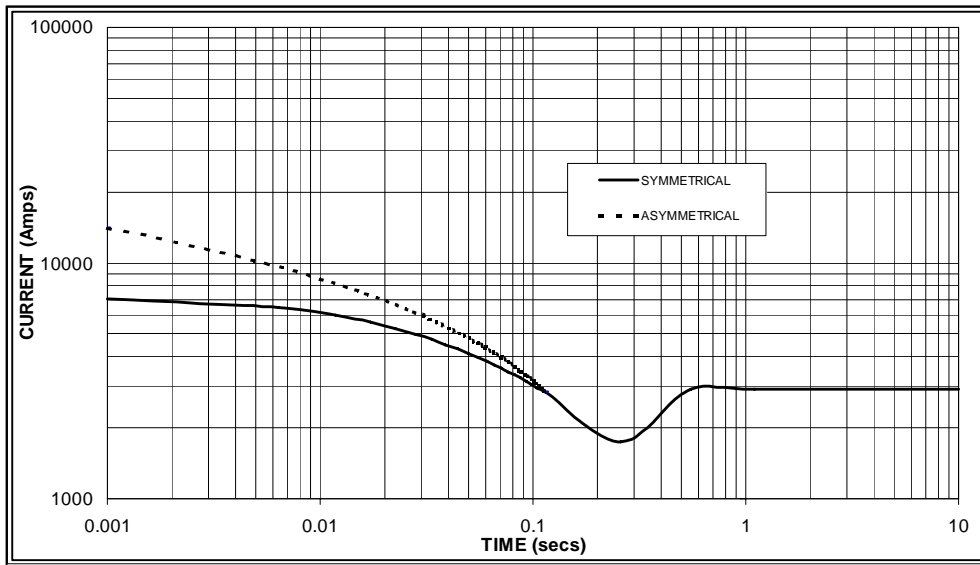

Sustained Short Circuit = 2,900 Amps



**60
Hz**

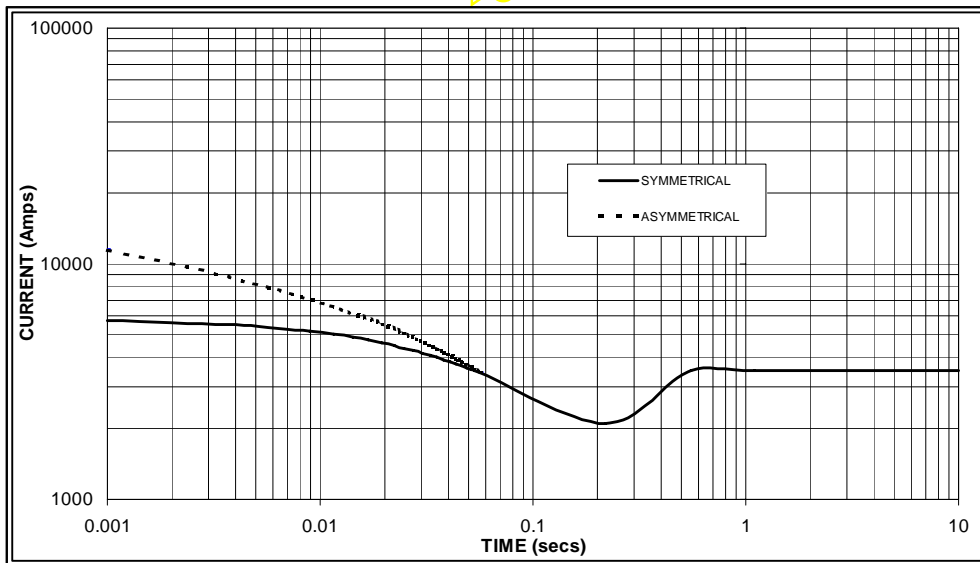

Sustained Short Circuit = 3,500 Amps

Note 1

The following multiplication factors should be used to adjust the values from curve between time 0.001 seconds and the minimum current point in respect of nominal operating voltage :

50Hz		60Hz	
Voltage	Factor	Voltage	Factor
380v	X 1.00	416v	x 1.00
400v	X 1.07	440v	x 1.06
415v	X 1.12	460v	x 1.12
440v	X 1.18	480v	x 1.17

The sustained current value is constant irrespective of voltage level

Note 2

The following multiplication factor should be used to convert the values calculated in accordance with NOTE 1 to those applicable to the various types of short circuit :

	3-phase	2-phase L-L	1-phase L-N
Instantaneous	x 1.00	x 0.87	x 1.30
Minimum	x 1.00	x 1.80	x 3.20
Sustained	x 1.00	x 1.50	x 2.50
Max. sustained duration	10 sec.	5 sec.	2 sec.

All other times are unchanged

Note 3

Curves are drawn for Star (Wye) connected machines. For Delta connection multiply the Curve current value by 1.732

RATINGS

Class - Temp Rise		Cont. F - 105/40°C				Cont. H - 125/40°C				Standby - 150/40°C				Standby - 163/27°C			
50Hz	Star (V)	380	400	415	440	380	400	415	440	380	400	415	440	380	400	415	440
	Parallel Star (V) *	180	200	208	220	180	200	208	220	180	200	208	220	180	200	208	220
	Delta (V)	220	230	240	254	220	230	240	254	220	230	240	254	220	230	240	254
	kVA	750	760	750	750	800	810	800	800	825	830	825	820	850	860	850	850
	kW	600	608	600	600	640	648	640	640	660	664	660	656	680	688	680	680
	Efficiency (%)	94.5	94.6	94.8	95.0	94.2	94.4	94.6	94.8	94.1	94.3	94.5	94.7	93.9	94.2	94.4	94.6
	kW Input	635	643	633	632	679	686	677	675	702	704	698	693	724	730	720	719
60Hz	Star (V)	416	440	460	480	416	440	460	480	416	440	460	480	416	440	460	480
	Parallel Star (V) *	208	220	230	240	208	220	230	240	208	220	230	240	208	220	230	240
	Delta (V)	240	254	266	277	240	254	266	277	240	254	266	277	240	254	266	277
	kVA	813	844	888	913	875	925	963	1000	913	969	1008	1046	950	1000	1044	1088
	kW	650	675	710	730	700	740	770	800	730	775	806	837	760	800	835	870
	Efficiency (%)	94.6	94.7	94.8	94.8	94.4	94.5	94.5	94.6	94.2	94.3	94.4	94.4	94.1	94.2	94.3	94.3
	kW Input	688	713	749	770	742	783	815	846	775	822	854	886	808	849	886	923

* Parallel Star only available with Wdg 311

DIMENSIONS

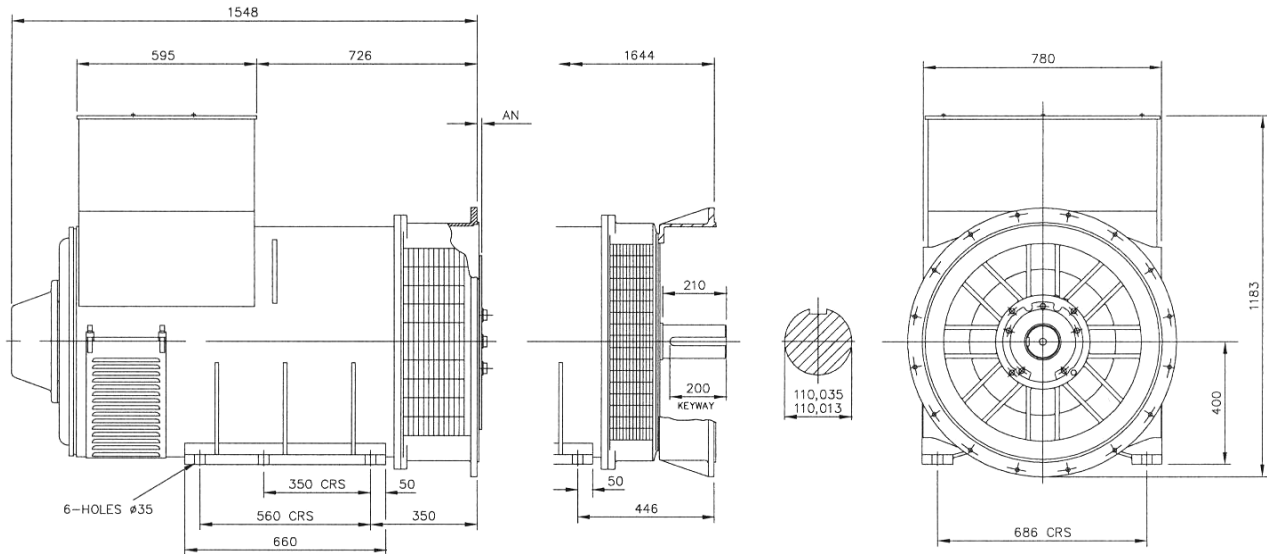

SAE	14	18	21	24
AN	25.4	15.87	0	0

APPROVED DOCUMENT

STAMFORD

Head Office Address:
Barnack Road, Stamford
Lincolnshire, PE9 2NB
United Kingdom
Tel: +44 (0) 1780 484000
Fax: +44 (0) 1780 484100

www.cumminsgeneratortechnologies.com

Copyright 2010, Cummins Generator Technologies Ltd, All Rights Reserved
Stamford and AvK are registered trade marks of Cummins Generator Technologies Ltd
Cummins and the Cummins logo are registered trade marks of Cummins Inc.

STAMFORD®

HCI 534F/544F - Winding 311

Technical **DATA** Sheet

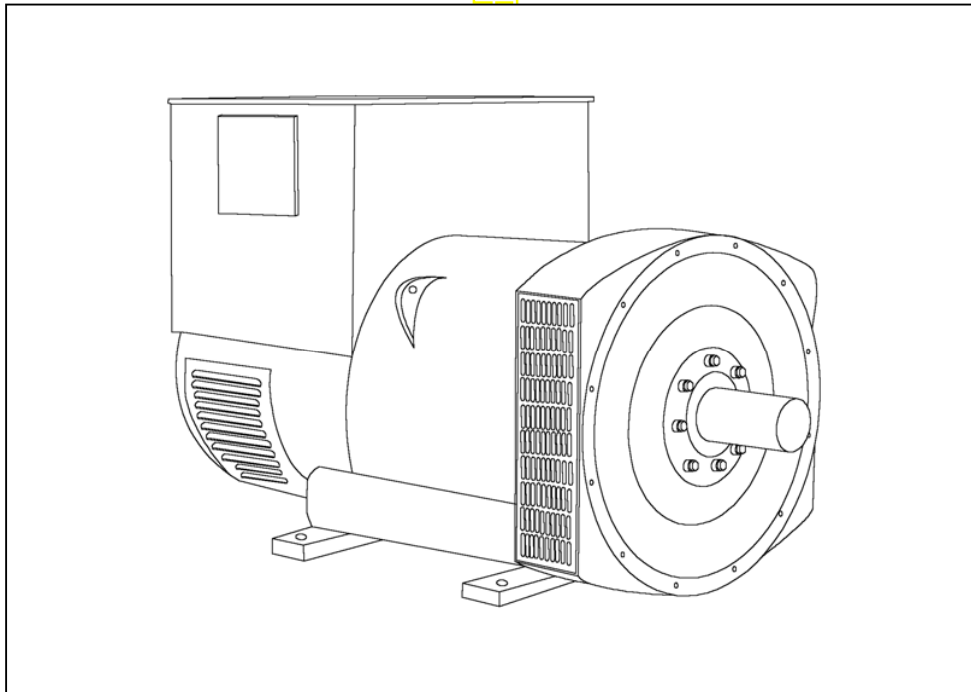

HCI534F/544F

SPECIFICATIONS & OPTIONS

STAMFORD

STANDARDS

Stamford industrial generators meet the requirements of BS EN 60034 and the relevant section of other international standards such as BS5000, VDE 0530, NEMA MG1-32, IEC34, CSA C22.2 100, AS1359.

Other standards and certifications can be considered on request.

VOLTAGE REGULATORS

AS440 AVR - STANDARD

With this self-excited system the main stator provides power via the Automatic Voltage Regulator (AVR) to the exciter stator. The high efficiency semi-conductors of the AVR ensure positive build-up from initial low levels of residual voltage.

The exciter rotor output is fed to the main rotor through a three-phase full-wave bridge rectifier. The rectifier is protected by a surge suppressor against surges caused, for example, by short circuit or out-of-phase paralleling.

The AS440 will support a range of electronic accessories, including a 'droop' Current Transformer (CT) to permit parallel operation with other ac generators.

MX341 AVR

This sophisticated AVR is incorporated into the Stamford Permanent Magnet Generator (PMG) control system.

The PMG provides power via the AVR to the main exciter, giving a source of constant excitation power independent of generator output. The main exciter output is then fed to the main rotor, through a full wave bridge, protected by a surge suppressor. The AVR has in-built protection against sustained over-excitation, caused by internal or external faults. This de-excites the machine after a minimum of 5 seconds.

An engine relief load acceptance feature can enable full load to be applied to the generator in a single step.

If three-phase sensing is required with the PMG system the MX321 AVR must be used.

We recommend three-phase sensing for applications with greatly unbalanced or highly non-linear loads.

MX321 AVR

The most sophisticated of all our AVRs combines all the features of the MX341 with, additionally, three-phase rms sensing, for improved regulation and performance.

Over voltage protection is built-in and short circuit current level adjustments is an optional facility.

WINDINGS & ELECTRICAL PERFORMANCE

All generator stators are wound to 2/3 pitch. This eliminates triplen (3rd, 9th, 15th ...) harmonics on the voltage waveform and is found to be the optimum design for trouble-free supply of non-linear loads. The 2/3 pitch design avoids excessive neutral currents sometimes seen with higher winding pitches, when in parallel with the mains. A fully connected damper winding reduces oscillations during paralleling. This winding, with the 2/3 pitch and carefully selected pole and tooth designs, ensures very low waveform distortion.

TERMINALS & TERMINAL BOX

Standard generators are 3-phase reconnectable with 12 ends brought out to the terminals, which are mounted on a cover at the non-drive end of the generator. A sheet steel terminal box contains the AVR and provides ample space for the customers' wiring and gland arrangements. It has removable panels for easy access.

SHAFT & KEYS

All generator rotors are dynamically balanced to better than BS6861:Part 1 Grade 2.5 for minimum vibration in operation. Two bearing generators are balanced with a half key.

INSULATION/IMPREGNATION

The insulation system is class 'H'.

All wound components are impregnated with materials and processes designed specifically to provide the high build required for static windings and the high mechanical strength required for rotating components.

QUALITY ASSURANCE

Generators are manufactured using production procedures having a quality assurance level to BS EN ISO 9001.

The stated voltage regulation may not be maintained in the presence of certain radio transmitted signals. Any change in performance will fall within the limits of Criteria 'B' of EN 61000-6-2:2001. At no time will the steady-state voltage regulation exceed 2%.

DE RATES

All values tabulated on page 8 are subject to the following reductions

5% when air inlet filters are fitted.

3% for every 500 metres by which the operating altitude exceeds 1000 metres above mean sea level.

3% for every 5°C by which the operational ambient temperature exceeds 40°C.

Note: Requirement for operating in an ambient exceeding 60°C must be referred to the factory.

NB Continuous development of our products entitles us to change specification details without notice, therefore they must not be regarded as binding.

Front cover drawing typical of product range.

WINDING 311

CONTROL SYSTEM	SEPARATELY EXCITED BY P.M.G.							
A.V.R.	MX321	MX341						
VOLTAGE REGULATION	± 0.5 %	± 1.0 %	With 4% ENGINE GOVERNING					
SUSTAINED SHORT CIRCUIT	REFER TO SHORT CIRCUIT DECREMENT CURVES (page 7)							
CONTROL SYSTEM	SELF EXCITED							
A.V.R.	AS440							
VOLTAGE REGULATION	± 1.0 %	With 4% ENGINE GOVERNING						
SUSTAINED SHORT CIRCUIT	SERIES 4 CONTROL DOES NOT SUSTAIN A SHORT CIRCUIT CURRENT							
INSULATION SYSTEM	CLASS H							
PROTECTION	IP23							
RATED POWER FACTOR	0.8							
STATOR WINDING	DOUBLE LAYER LAP							
WINDING PITCH	TWO THIRDS							
WINDING LEADS	12							
STATOR WDG. RESISTANCE	0.0037 Ohms PER PHASE AT 22°C SERIES STAR CONNECTED							
ROTOR WDG. RESISTANCE	2.16 Ohms at 22°C							
EXCITER STATOR RESISTANCE	17 Ohms at 22°C							
EXCITER ROTOR RESISTANCE	0.092 Ohms PER PHASE AT 22°C							
R.F.I. SUPPRESSION	BS EN 61000-6-2 & BS EN 61000-6-4, VDE 0875G, VDE 0875N. refer to factory for others							
WAVEFORM DISTORTION	NO LOAD < 1.5% NON-DISTORTING BALANCED LINEAR LOAD < 5.0%							
MAXIMUM OVERSPEED	2250 Rev/Min							
BEARING DRIVE END	BALL. 6220 (ISO)							
BEARING NON-DRIVE END	BALL. 6314 (ISO)							
	1 BEARING				2 BEARING			
WEIGHT COMP. GENERATOR	1685 kg				1694 kg			
WEIGHT WOUND STATOR	805 kg				805 kg			
WEIGHT WOUND ROTOR	684 kg				655 kg			
WR ² INERTIA	10.033 kgm ²				9.7551 kgm ²			
SHIPPING WEIGHTS in a crate	1775 kg				1780kg			
PACKING CRATE SIZE	166 x 87 x 124(cm)				166 x 87 x 124(cm)			
	50 Hz				60 Hz			
TELEPHONE INTERFERENCE	THF<2%				TIF<50			
COOLING AIR	1.035 m ³ /sec 2202 cfm				1.312 m ³ /sec 2780 cfm			
VOLTAGE SERIES STAR	380/220	400/231	415/240	440/254	416/240	440/254	460/266	480/277
VOLTAGE PARALLEL STAR	190/110	200/115	208/120	220/127	208/120	220/127	230/133	240/138
VOLTAGE SERIES DELTA	220/110	230/115	240/120	254/127	240/120	254/127	266/133	277/138
KVA BASE RATING FOR REACTANCE VALUES	670	670	670	650	738	775	800	825
X _d DIR. AXIS SYNCHRONOUS	2.90	2.62	2.43	2.10	3.33	3.13	2.95	2.80
X' _d DIR. AXIS TRANSIENT	0.16	0.14	0.13	0.11	0.16	0.15	0.14	0.13
X'' _d DIR. AXIS SUBTRANSIENT	0.11	0.10	0.09	0.08	0.11	0.10	0.10	0.09
X _q QUAD. AXIS REACTANCE	2.42	2.19	2.03	1.75	2.66	2.50	2.36	2.23
X' _q QUAD. AXIS SUBTRANSIENT	0.25	0.23	0.21	0.18	0.31	0.29	0.27	0.26
X _L LEAKAGE REACTANCE	0.05	0.04	0.04	0.03	0.05	0.05	0.04	0.04
X ₂ NEGATIVE SEQUENCE	0.18	0.16	0.15	0.13	0.21	0.20	0.19	0.18
X ₀ ZERO SEQUENCE	0.08	0.08	0.07	0.06	0.09	0.08	0.08	0.08
REACTANCES ARE SATURATED				VALUES ARE PER UNIT AT RATING AND VOLTAGE INDICATED				
T' _d TRANSIENT TIME CONST.	0.08s							
T'' _d SUB-TRANSTIME CONST.	0.012s							
T' _{do} O.C. FIELD TIME CONST.	2.5s							
T _a ARMATURE TIME CONST.	0.019s							
SHORT CIRCUIT RATIO	1/X _d							

**50
Hz**

HCI534F/544F

STAMFORD

Winding 311

THREE PHASE EFFICIENCY CURVES

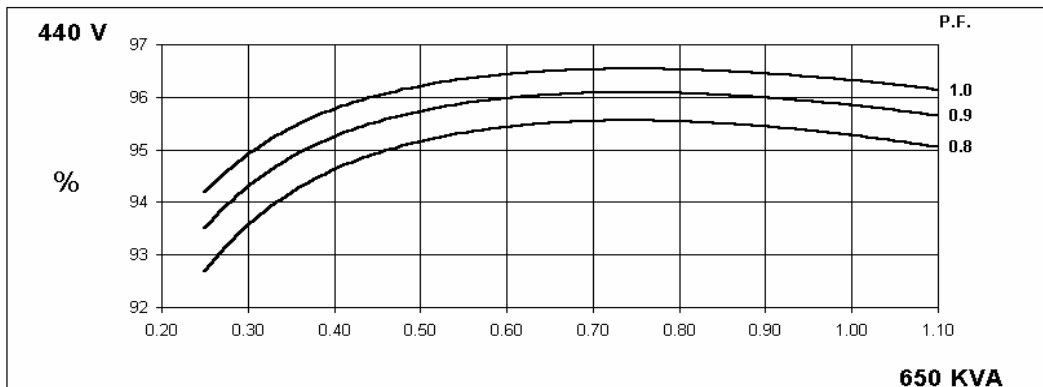
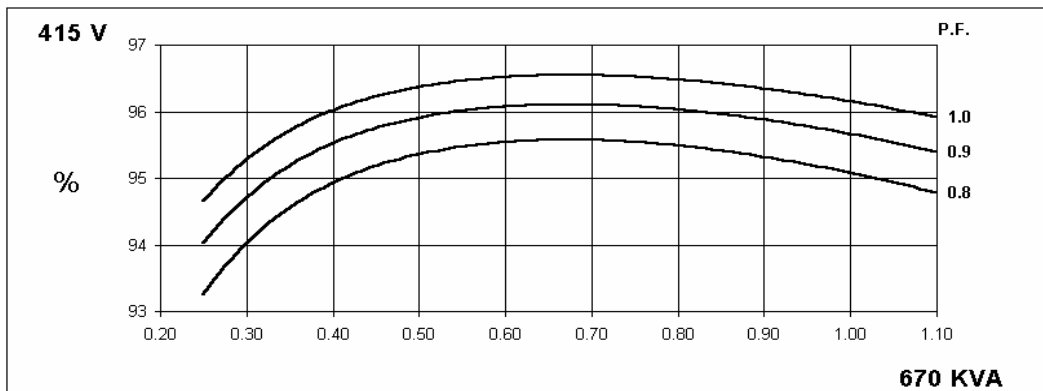
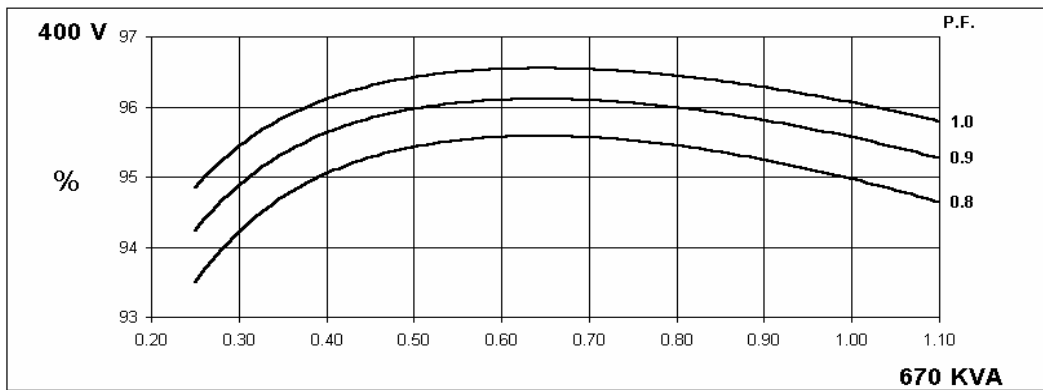
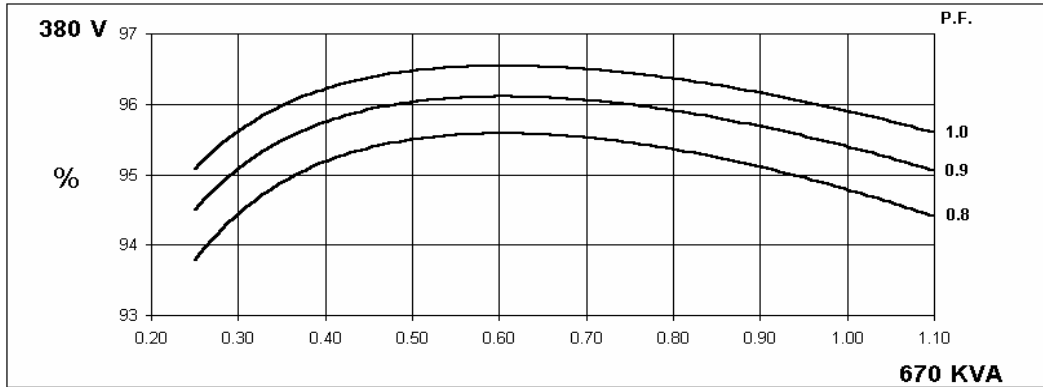

**60
Hz**

HCI534F/544F

STAMFORD

Winding 311

THREE PHASE EFFICIENCY CURVES

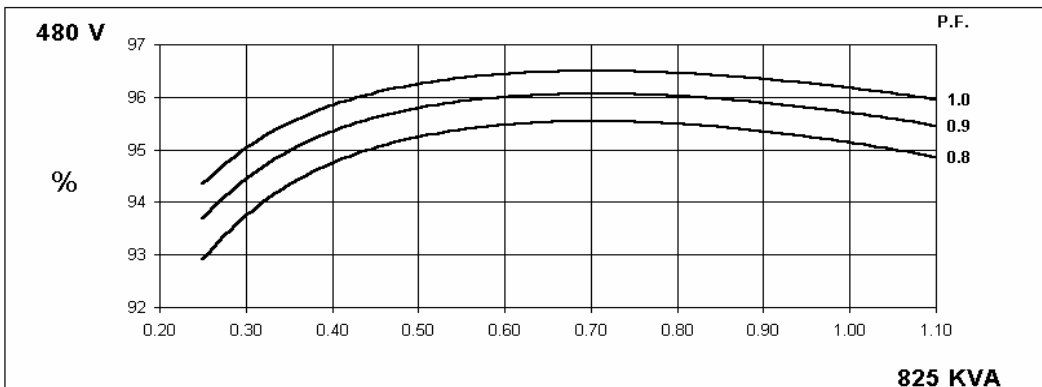
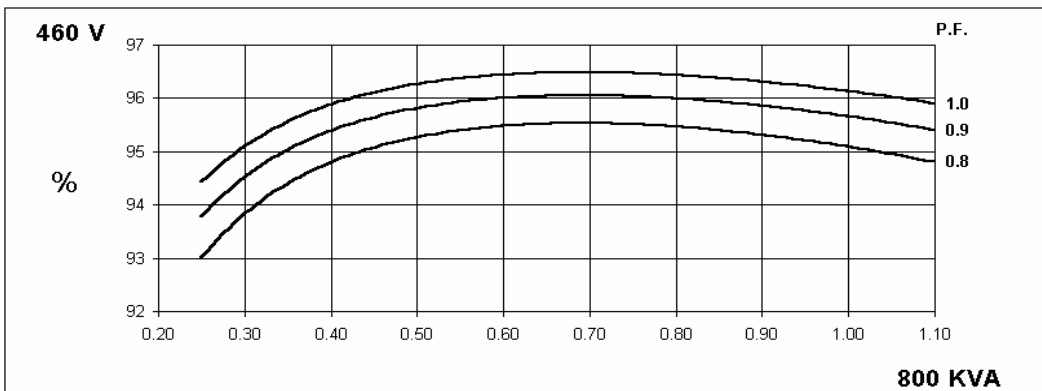
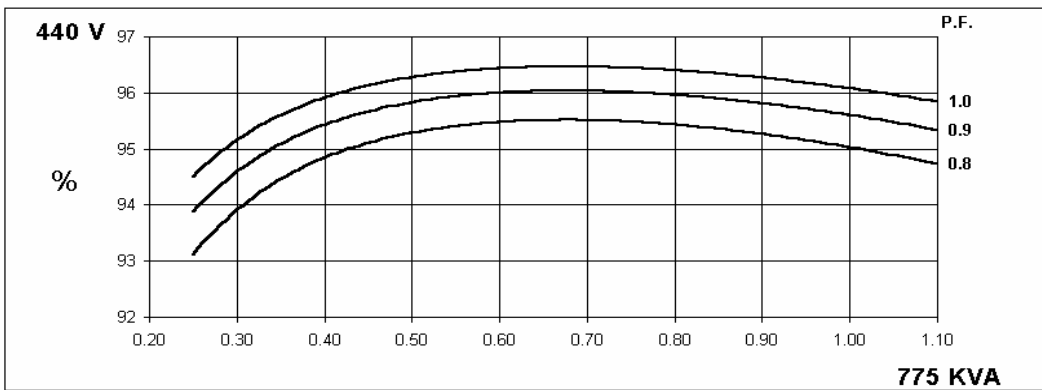
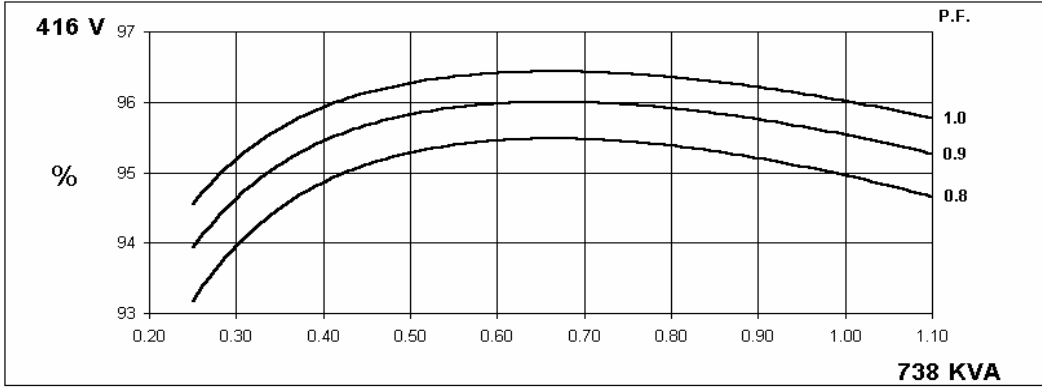

Locked Rotor Motor Starting Curve

**50
Hz**

MX

SX

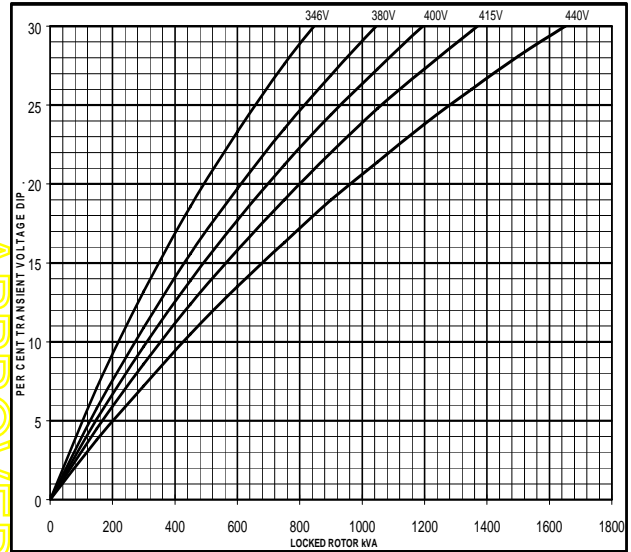
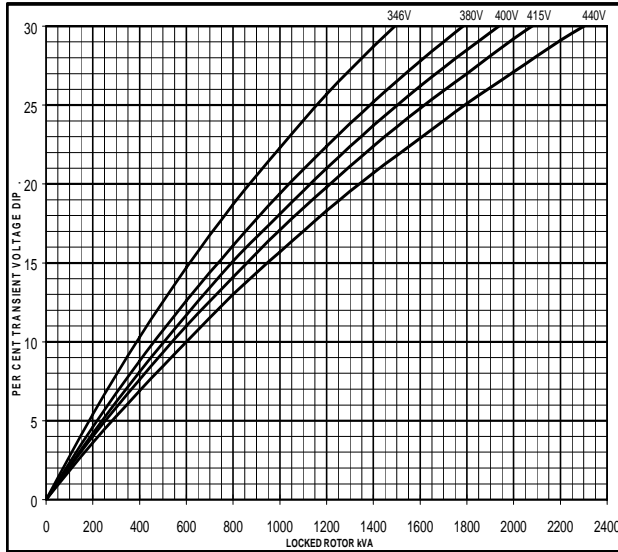

**60
Hz**

MX

SX

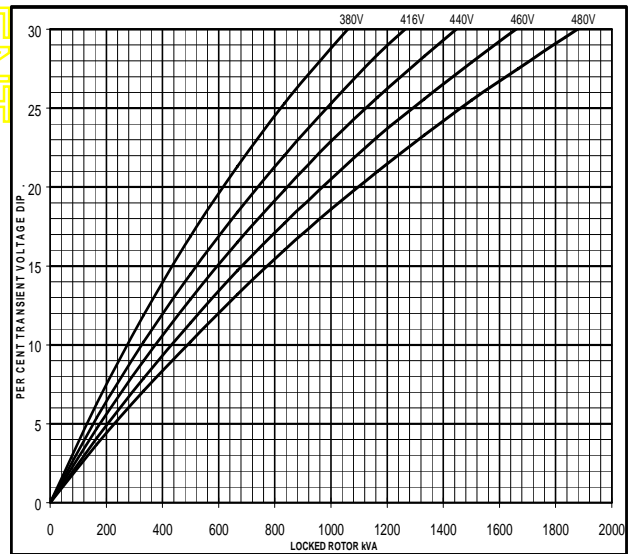
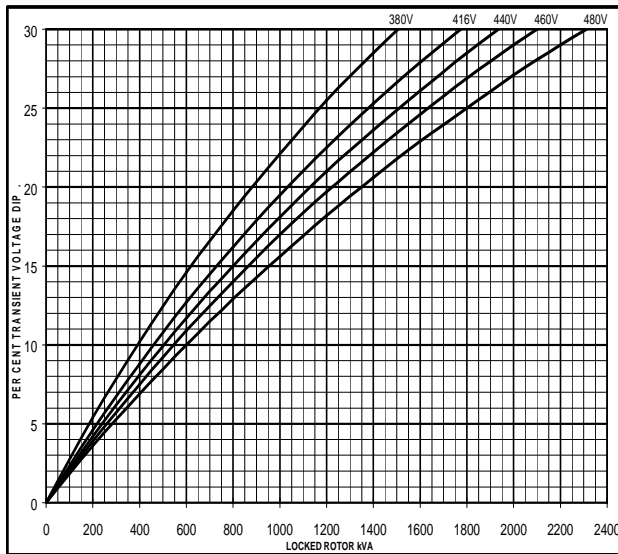

APPROVED DOCUMENT

Three-phase Short Circuit Decrement Curve. No-load Excitation at Rated Speed
Based on star (wye) connection.

**50
Hz**

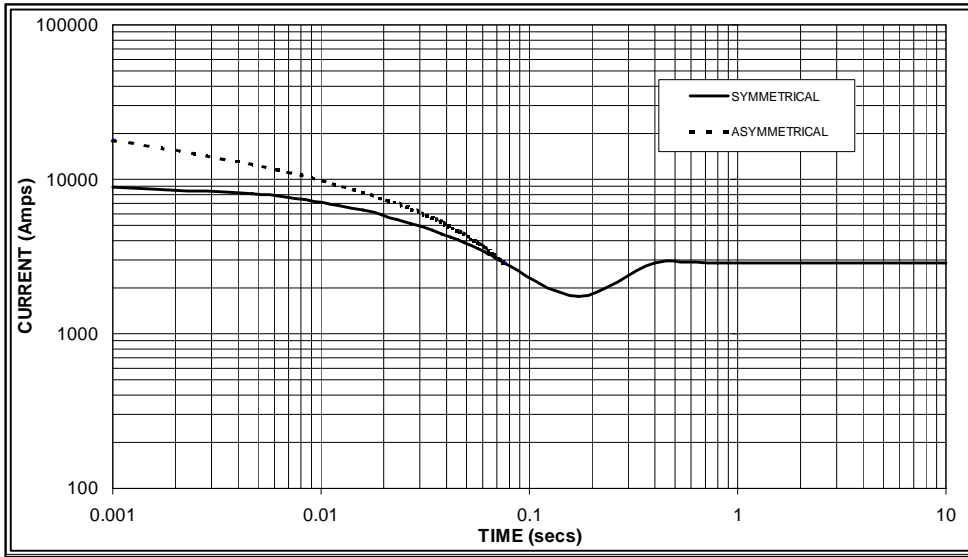

Sustained Short Circuit = 2,900 Amps



**60
Hz**

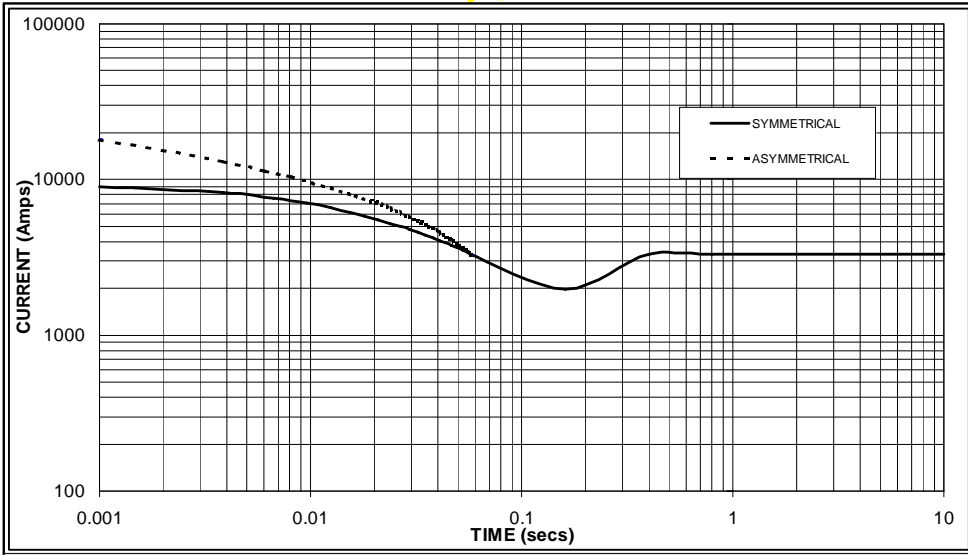

Sustained Short Circuit = 3,300 Amps

Note 1

The following multiplication factors should be used to adjust the values from curve between time 0.001 seconds and the minimum current point in respect of nominal operating voltage :

50Hz		60Hz	
Voltage	Factor	Voltage	Factor
380v	X 1.00	416v	X 1.00
400v	X 1.06	440v	X 1.06
415v	X 1.09	460v	X 1.12
440v	X 1.12	480v	X 1.20

The sustained current value is constant irrespective of voltage level

Note 2

The following multiplication factor should be used to convert the values calculated in accordance with NOTE 1 to those applicable to the various types of short circuit :

	3-phase	2-phase L-L	1-phase L-N
Instantaneous	x 1.00	x 0.87	x 1.30
Minimum	x 1.00	x 1.80	x 3.20
Sustained	x 1.00	x 1.50	x 2.50
Max. sustained duration	10 sec.	5 sec.	2 sec.

All other times are unchanged

Note 3

Curves are drawn for Star (Wye) connected machines. For other connections the following multipliers should be applied to current values as shown :

Parallel Star = Curve current value X 2

Series Delta = Curve current value X 1.732

HCI534F/544F

STAMFORD

Winding 311 0.8 Power Factor

RATINGS

Class - Temp Rise		Cont. F - 105/40°C				Cont. H - 125/40°C				Standby - 150/40°C				Standby - 163/27°C			
50 Hz	Series Star (V)	380	400	415	440	380	400	415	440	380	400	415	440	380	400	415	440
	Parallel Star (V)	190	200	208	220	190	200	208	220	190	200	208	220	190	200	208	220
	Series Delta (V)	220	230	240	254	220	230	240	254	220	230	240	254	220	230	240	254
	kVA	620	620	620	600	670	670	670	650	710	710	710	690	738	738	738	715
	kW	496	496	496	480	536	536	536	520	568	568	568	552	590	590	590	572
	Efficiency (%)	95.0	95.2	95.3	95.4	94.8	95.0	95.1	95.3	94.6	94.8	94.9	95.1	94.4	94.6	94.8	95.1
	kW Input	522	521	520	503	565	564	564	546	600	599	599	580	625	624	623	601

60 Hz	Series Star (V)	416	440	460	480	416	440	460	480	416	440	460	480	416	440	460	480
	Parallel Star (V)	208	220	230	240	208	220	230	240	208	220	230	240	208	220	230	240
	Delta (V)	240	254	266	277	240	254	266	277	240	254	266	277	240	254	266	277
	kVA	688	719	731	750	738	775	800	825	781	819	848	875	806	844	878	906
	kW	550	575	585	600	590	620	640	660	625	655	678	700	645	675	702	725
	Efficiency (%)	95.1	95.2	95.3	95.3	95.0	95.0	95.1	95.1	94.8	94.9	94.9	95.0	94.7	94.8	94.8	94.9
	kW Input	579	604	614	630	621	653	673	694	659	690	715	737	681	712	741	764

DIMENSIONS

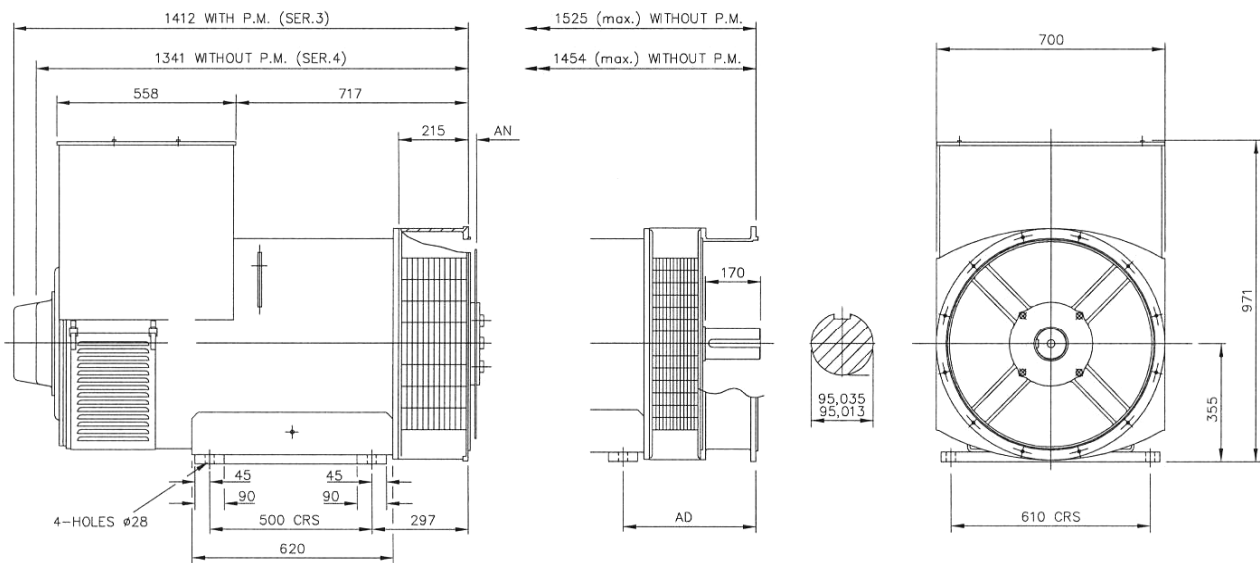

COUPLING DISC	AN
SAE 14	25,4
SAE 18	15,87
SAE 21	0

ADAPTOR	AD
SAE 00	410
SAE 0	410
SAE 1/2	390
SAE 1	390

APPROVED DOCUMENT

STAMFORD

Head Office Address:
Barnack Road, Stamford
Lincolnshire, PE9 2NB
United Kingdom
Tel: +44 (0) 1780 484000
Fax: +44 (0) 1780 484100

www.cumminsgeneratortechnologies.com

Copyright 2010, Cummins Generator Technologies Ltd, All Rights Reserved
Stamford and AvK are registered trade marks of Cummins Generator Technologies Ltd
Cummins and the Cummins logo are registered trade marks of Cummins Inc.

STAMFORD[®]

HCI534F/544F - Winding 17

Technical  Data Sheet

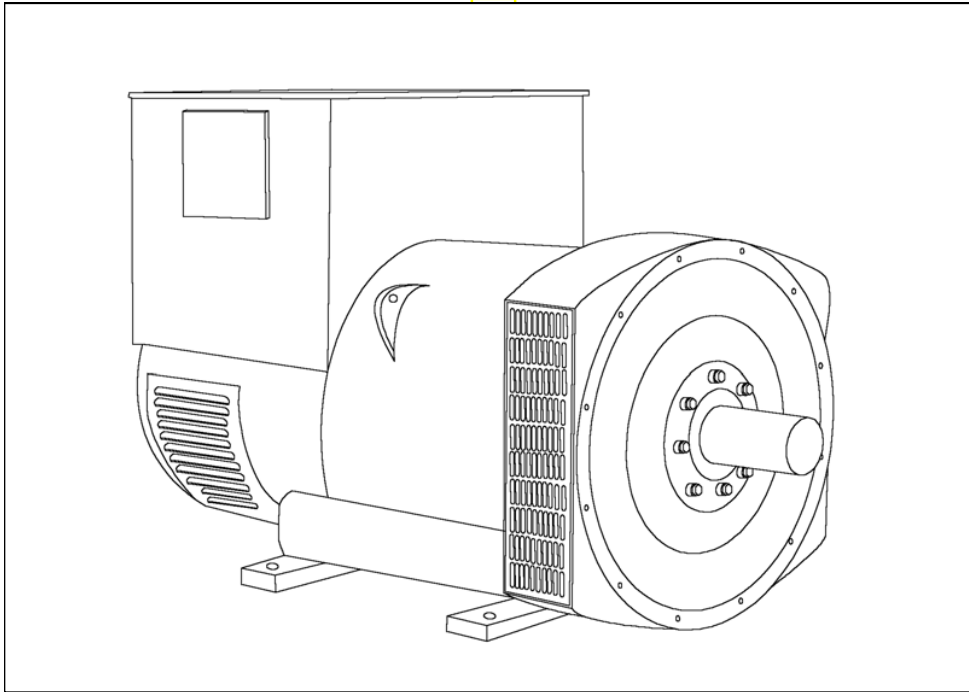

HCI534F/544F

SPECIFICATIONS & OPTIONS

STAMFORD

STANDARDS

Stamford industrial generators meet the requirements of BS EN 60034 and the relevant section of other international standards such as BS5000, VDE 0530, NEMA MG1-32, IEC34, CSA C22.2-100, AS1359. Other standards and certifications can be considered on request.

VOLTAGE REGULATORS

AS440 AVR - STANDARD

With this self-excited system the main stator provides power via the Automatic Voltage Regulator (AVR) to the exciter stator. The high efficiency semi-conductors of the AVR ensure positive build-up from initial low levels of residual voltage.

The exciter rotor output is fed to the main rotor through a three-phase full-wave bridge rectifier. The rectifier is protected by a surge suppressor against surges caused, for example, by short circuit or out-of-phase paralleling.

The AS440 will support a range of electronic accessories, including a 'droop' Current Transformer (CT) to permit parallel operation with other ac generators.

MX341 AVR

This sophisticated AVR is incorporated into the Stamford Permanent Magnet Generator (PMG) control system.

The PMG provides power via the AVR to the main exciter, giving a source of constant excitation power independent of generator output. The main exciter output is then fed to the main rotor, through a full wave bridge, protected by a surge suppressor. The AVR has in-built protection against sustained over-excitation, caused by internal or external faults. This de-excites the machine after a minimum of 5 seconds.

An engine relief load acceptance feature can enable full load to be applied to the generator in a single step.

If three-phase sensing is required with the PMG system the MX321 AVR must be used.

We recommend three-phase sensing for applications with greatly unbalanced or highly non-linear loads.

MX321 AVR

The most sophisticated of all our AVRs combines all the features of the MX341 with, additionally, three-phase rms sensing, for improved regulation and performance.

Over voltage protection is built-in and short circuit current level adjustments is an optional facility.

WINDINGS & ELECTRICAL PERFORMANCE

All generator stators are wound to 2/3 pitch. This eliminates triplen (3rd, 9th, 15th ...) harmonics on the voltage waveform and is found to be the optimum design for trouble-free supply of non-linear loads. The 2/3 pitch design avoids excessive neutral currents sometimes seen with higher winding pitches, when in parallel with the mains. A fully connected damper winding reduces oscillations during paralleling. This winding, with the 2/3 pitch and carefully selected pole and tooth designs, ensures very low waveform distortion.

TERMINALS & TERMINAL BOX

Standard generators are 3-phase reconnectable with 12 ends brought out to the terminals, which are mounted on a cover at the non-drive end of the generator. A sheet steel terminal box contains the AVR and provides ample space for the customers' wiring and gland arrangements. It has removable panels for easy access.

SHAFT & KEYS

All generator rotors are dynamically balanced to better than BS6861:Part 1 Grade 2.5 for minimum vibration in operation. Two bearing generators are balanced with a half key.

INSULATION/IMPREGNATION

The insulation system is class 'H'.

All wound components are impregnated with materials and processes designed specifically to provide the high build required for static windings and the high mechanical strength required for rotating components.

QUALITY ASSURANCE

Generators are manufactured using production procedures having a quality assurance level to BS EN ISO 9001.

The stated voltage regulation may not be maintained in the presence of certain radio transmitted signals. Any change in performance will fall within the limits of Criteria 'B' of EN 61000-6-2:2001. At no time will the steady-state voltage regulation exceed 2%.

DE RATES

All values tabulated on page 6 are subject to the following reductions

5% when air inlet filters are fitted.

3% for every 500 metres by which the operating altitude exceeds 1000 metres above mean sea level.

3% for every 5 C by which the operational ambient temperature exceeds 40 C.

Note: Requirement for operating in an ambient exceeding 60 C must be referred to the factory.

NB Continuous development of our products entitles us to change specification details without notice, therefore they must not be regarded as binding.

Front cover drawing typical of product range.

APPROVED DOCUMENT

HCI534F/544F

STAMFORD

WINDING 17

CONTROL SYSTEM	SEPARATELY EXCITED BY P.M.G.		
A.V.R.	MX321	MX341	
VOLTAGE REGULATION	± 0.5 %	± 1.0 %	With 4% ENGINE GOVERNING
SUSTAINED SHORT CIRCUIT	REFER TO SHORT CIRCUIT DECREMENT CURVES (page 5)		
CONTROL SYSTEM	SELF EXCITED		
A.V.R.	AS440		
VOLTAGE REGULATION	± 1.0 %		With 4% ENGINE GOVERNING
SUSTAINED SHORT CIRCUIT	WILL NOT SUSTAIN A SHORT CIRCUIT		
INSULATION SYSTEM	CLASS H		
PROTECTION	IP23		
RATED POWER FACTOR	0.8		
STATOR WINDING	DOUBLE LAYER LAP		
WINDING PITCH	TWO THIRDS		
WINDING LEADS	12		
STATOR WDG. RESISTANCE	0.0049 Ohms PER PHASE AT 22°C SERIES STAR CONNECTED		
ROTOR WDG. RESISTANCE	2.16 Ohms at 22°C		
EXCITER STATOR RESISTANCE	17 Ohms at 22°C		
EXCITER ROTOR RESISTANCE	0.092 Ohms PER PHASE AT 22°C		
R.F.I. SUPPRESSION	BS EN 61000-6-2 & BS EN 61000-6-4, VDE 0875G, VDE 0875N. refer to factory for others		
WAVEFORM DISTORTION	NO LOAD < 1.5% NON-DISTORTING BALANCED LINEAR LOAD < 5.0%		
MAXIMUM OVERSPEED	2250 Rev/Min		
BEARING DRIVE END	BALL. 6220 (ISO)		
BEARING NON-DRIVE END	BALL. 6314 (ISO)		
	1 BEARING		2 BEARING
WEIGHT COMP. GENERATOR	1685 kg		1694 kg
WEIGHT WOUND STATOR	805 kg		805 kg
WEIGHT WOUND ROTOR	684 kg		655 kg
WR ² INERTIA	10.033 kgm ²		9.7551 kgm ²
SHIPPING WEIGHTS in a crate	1775 kg		1780 kg
PACKING CRATE SIZE	166 x 87 x 124 (cm)		166 x 87 x 124 (cm)
TELEPHONE INTERFERENCE	THF<2%		TIF<50
COOLING AIR	1.035 m ³ /sec 2202 cfm		
VOLTAGE SERIES STAR	600V		
VOLTAGE PARALLEL STAR	300V		
VOLTAGE SERIES DELTA	346V		
kVA BASE RATING FOR REACTANCE VALUES	825		
X _d DIR. AXIS SYNCHRONOUS	2.44		
X' _d DIR. AXIS TRANSIENT	0.11		
X'' _d DIR. AXIS SUBTRANSIENT	0.09		
X _q QUAD. AXIS REACTANCE	1.95		
X'' _q QUAD. AXIS SUBTRANSIENT	0.23		
X _L LEAKAGE REACTANCE	0.04		
X ₂ NEGATIVE SEQUENCE	0.16		
X ₀ ZERO SEQUENCE	0.07		
REACTANCES ARE SATURATED		VALUES ARE PER UNIT AT RATING AND VOLTAGE INDICATED	
T' _d TRANSIENT TIME CONST.	0.08 s		
T'' _d SUB-TRANSTIME CONST.	0.012 s		
T' _{do} O.C. FIELD TIME CONST.	2.5 s		
T _a ARMATURE TIME CONST.	0.019 s		
SHORT CIRCUIT RATIO	1/X _d		

HCI534F/544F

STAMFORD

Winding 17

SX

Locked Rotor Motor Starting Curves

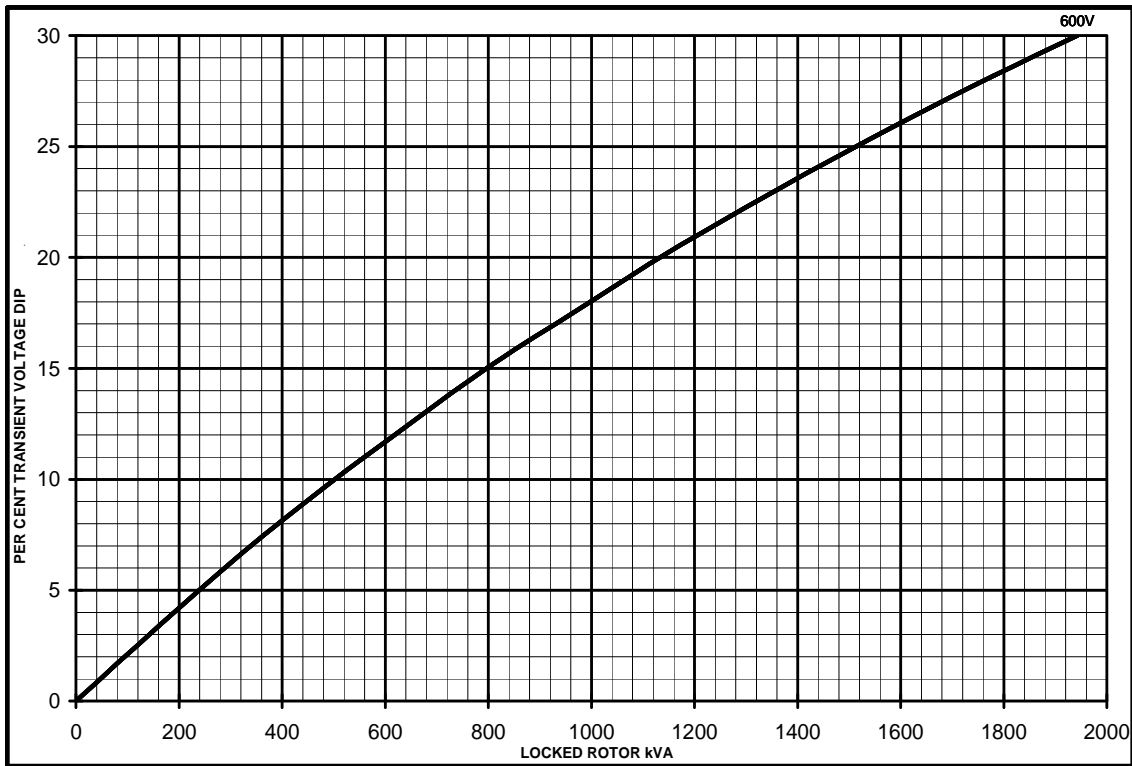

MX

OCU

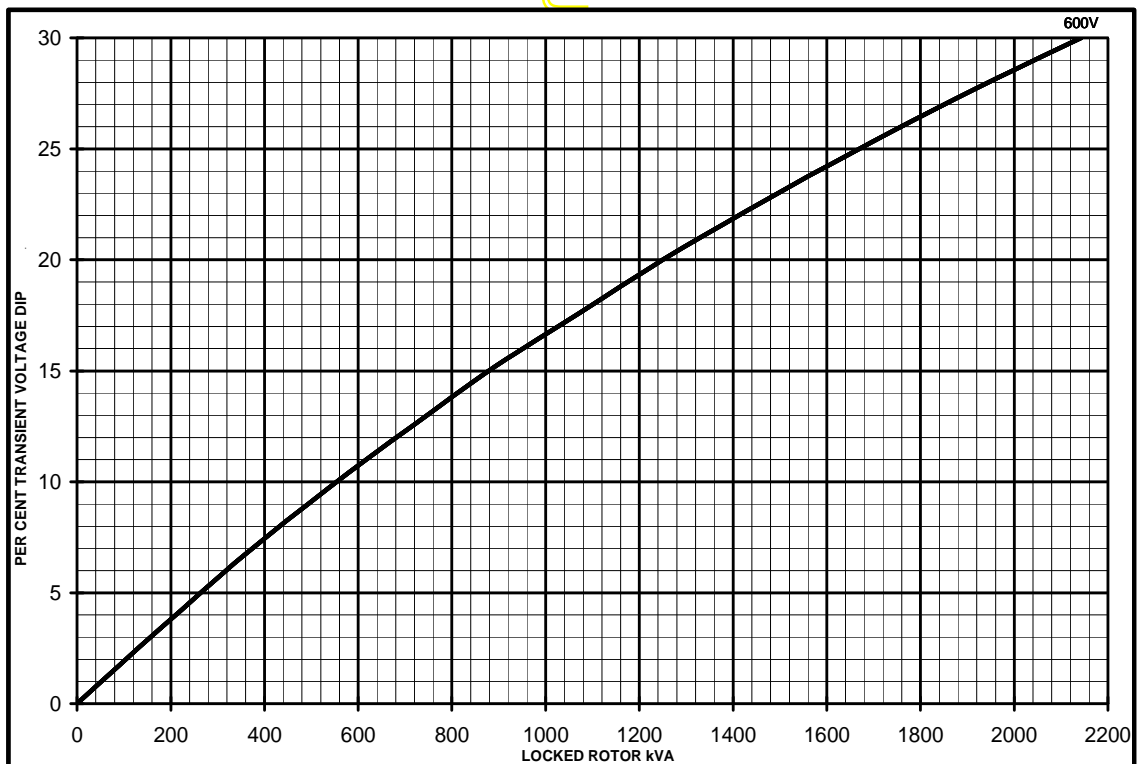

HCI534F/544F
Winding 17

STAMFORD

THREE PHASE EFFICIENCY CURVES

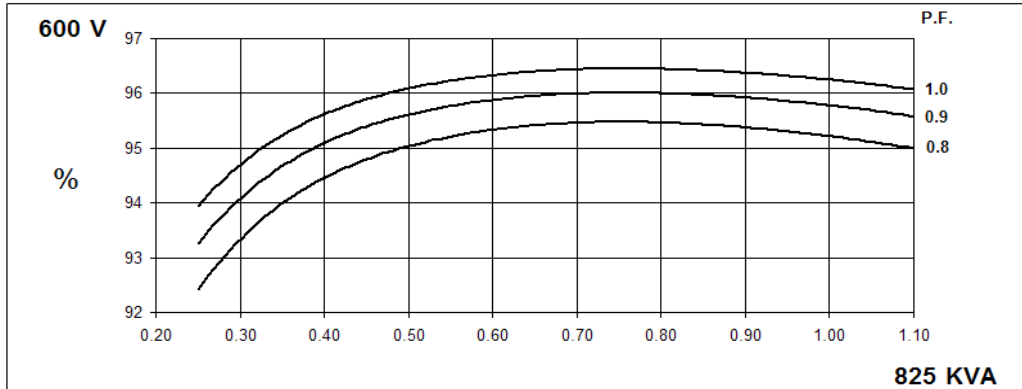

Three-phase Short Circuit Decrement Curve. No-load Excitation at Rated Speed Based on star (wye) connection.

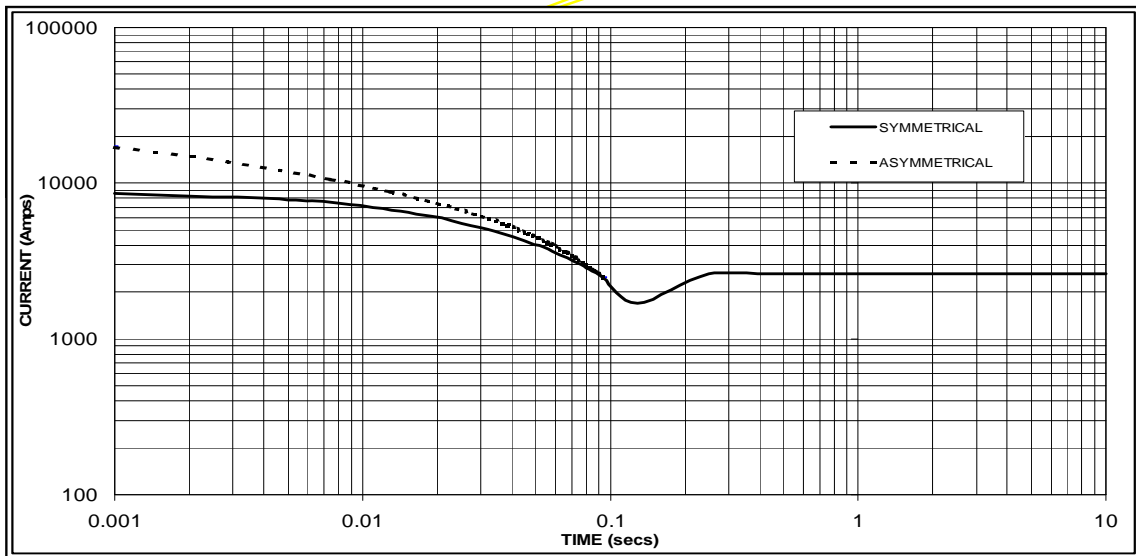

Sustained Short Circuit = 2600 Amps

Note

The following multiplication factor should be used to convert the values from curve for the various types of short circuit :

	3-phase	2-phase L-L	1-phase L-N
Instantaneous	x 1.00	x 0.87	x 1.30
Minimum	x 1.00	x 1.80	x 3.20
Sustained	x 1.00	x 1.50	x 2.50
Max. sustained duration	10 sec.	5 sec.	2 sec.

All other times are unchanged

HCI534F/544F
Winding 17 / 0.8 Power Factor

STAMFORD

60Hz

RATINGS

Class - Temp Rise	Cont. F - 105/40°C	Cont. H - 125/40°C	Standby - 150/40°C	Standby - 163/27°C
Series Star (V)	600	600	600	600
Parallel Star (V)	300	300	300	300
Series Delta (V)	346	346	346	346
kVA	750	825	875	906
kW	600	660	700	725
Efficiency (%)	95.4	95.2	95.1	95.0
kW Input	629	692	734	760

APPROVED

DIMENSIONS

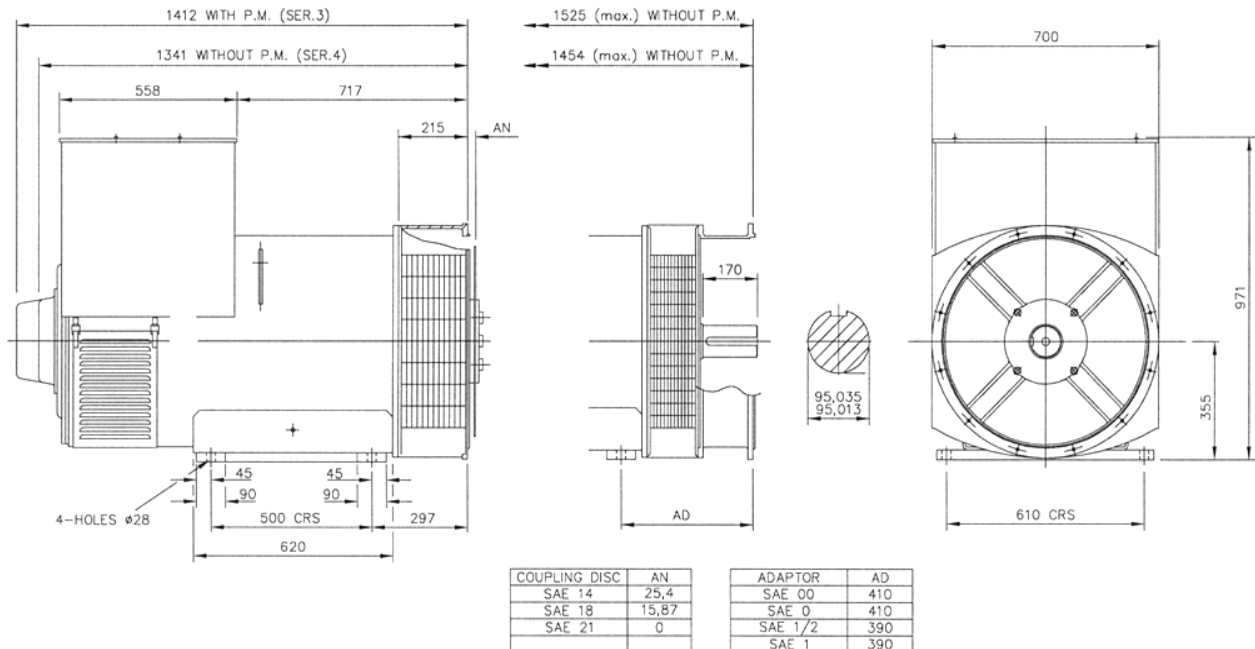

APPROVED DOCUMENT

STAMFORD

Head Office Address:
Barnack Road, Stamford
Lincolnshire, PE9 2NB
United Kingdom
Tel: +44 (0) 1780 484000
Fax: +44 (0) 1780 484100

www.cumminsgeneratortechnologies.com

Copyright 2010, Cummins Generator Technologies Ltd, All Rights Reserved
Stamford and AvK are registered trade marks of Cummins Generator Technologies Ltd
Cummins and the Cummins logo are registered trade marks of Cummins Inc.

DSE7410/20

AUTO START & AUTO MAINS FAILURE MODULES

FEATURES



The DSE7410 is an Auto Start Control Module and the **DSE7420** is an Auto Mains (Utility) Failure Control Module suitable for a wide variety of single, diesel or gas, gen-set applications.

A sophisticated module monitoring an extensive number of engine parameters, the DSE74xx will announce warnings, shutdown and engine status information on the back-lit LCD screen, illuminated LED, remote PC, audible alarm and via SMS text alerts. The module includes RS232, RS485 & Ethernet ports as well as dedicated terminals for system expansion.

The DSE7400 Series modules are compatible with electronic (CAN) and non-electronic (magnetic pick-up/alternator sensing) engines and offer a comprehensive number of flexible inputs, outputs and extensive engine protections so the system can be easily adapted to meet the most demanding industry paralleling requirements.

The modules can be easily configured using the DSE Configuration Suite Software. Selected front panel editing is also available.

ENVIRONMENTAL TESTING STANDARDS

ELECTRO-MAGNETIC COMPATIBILITY

BS EN 61000-6-2
EMC Generic Immunity Standard for the Industrial Environment
BS EN 61000-6-4
EMC Generic Emission Standard for the Industrial Environment

ELECTRICAL SAFETY

BS EN 60950
Safety of Information Technology Equipment, including Electrical Business Equipment

TEMPERATURE

BS EN 60068-2-1
Ab/Ae Cold Test -30 °C
BS EN 60068-2-2
Bb/Be Dry Heat +70 °C

VIBRATION

BS EN 60068-2-6
Ten sweeps in each of three major axes
5 Hz to 8 Hz @ +/-7.5 mm,
8 Hz to 500 Hz @ 2 gn

HUMIDITY

BS EN 60068-2-30
Db Damp Heat Cyclic 20/55 °C @ 95% RH 48 Hours
BS EN 60068-2-78
Cab Damp Heat Static 40 °C @ 93% RH 48 Hours

SHOCK

BS EN 60068-2-27
Three shocks in each of three major axes
15 gn in 11 ms

DEGREES OF PROTECTION PROVIDED BY ENCLOSURES

BS EN 60529
IP65 - Front of module when installed into the control panel with the supplied sealing gasket.

COMPREHENSIVE FEATURE LIST TO SUIT A WIDE VARIETY OF GEN-SET APPLICATIONS

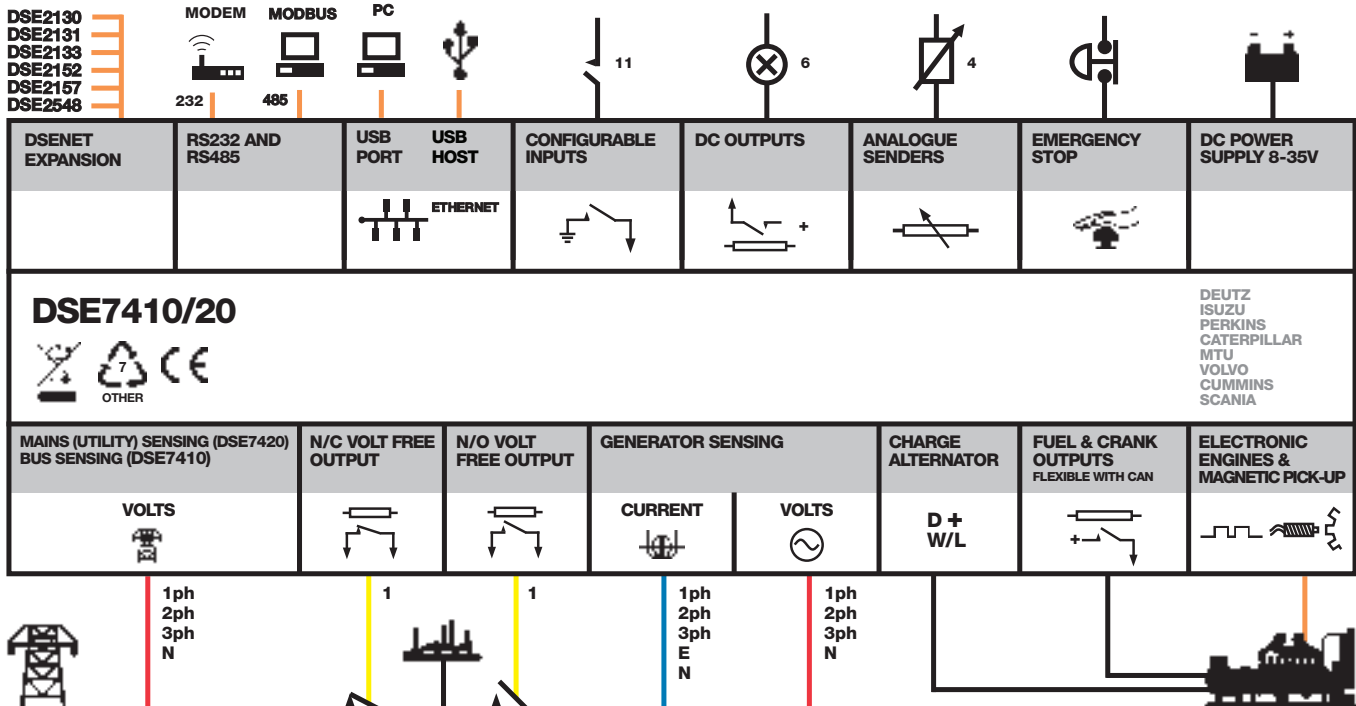

DSE7410/20

AUTO START & AUTO MAINS FAILURE MODULES

FEATURES



DSE7410



KEY FEATURES

- Configurable inputs (11)
- Configurable outputs (8)
- Voltage measurement
- Mains (utility) failure detection
- Dedicated load test button
- kW overload alarms
- Comprehensive electrical protection
- RS232, RS485 & Ethernet remote communications
- Modbus RTU/TCP
- PLC functionality
- Multi event exercise timer
- Back-lit LCD 4-line text display
- Multiple display languages
- Automatic start/Manual start
- Audible alarm
- Fixed and flexible LED indicators
- Event log (250)
- Engine protection
- Fault condition notification to a designated PC
- Front panel mounting
- Protected front panel programming
- Configurable alarms and timers
- Configurable start and stop timers

DSE7420



- Five key menu navigation
- Front panel editing with PIN protection
- 3 configurable maintenance alarms
- CAN and magnetic pick-up/Alt. sensing
- Fuel usage monitor and low fuel alarms
- Charge alternator failure alarm
- Manual speed control (on compatible CAN engines)
- Manual fuel pump control
- "Protections disabled" feature
- Reverse power protection
- Power monitoring (kW h, kV Ar, kV A h, kV Ar h)
- Load switching (load shedding and dummy load outputs)
- Automatic load transfer (DSE7420)
- Unbalanced load protection
- Independent earth fault trip
- Fully configurable via DSE Configuration Suite PC software
- Configurable display languages
- Remote SCADA monitoring via DSE Configuration Suite PC software

- Advanced SMS messaging (additional external modem required)
- Start & stop capability via SMS messaging
- Additional display screens to help with modem diagnostics
- DSENet® expansion
- Integral PLC editor

KEY BENEFITS

- RS232, RS485 & Ethernet can be used at the same time
- DSENet® connection for system expansion
- PLC functionality
- Five step dummy load support
- Five step load shedding support
- High number of inputs and outputs
- Worldwide language support
- Direct USB connection to PC
- Ethernet monitoring
- USB host
- Data logging & trending

RELATED MATERIALS

TITLE

DSE7410 Installation Instructions
DSE7420 Installation Instructions
 DSE74xx Quick Start Guide
 DSE74xx Operator Manual
 DSE74xx PC Configuration Suite Manual

PART NO'S

053-085
 053-088
 057-162
 057-161
 057-160

SPECIFICATION

DC SUPPLY
CONTINUOUS VOLTAGE RATING
 8 V to 35 V Continuous

CRANKING DROPOUTS
 Able to survive 0 V for 50 ms, providing supply was at least 10 V before dropout and supply recovers to 5 V. This is achieved without the need for internal batteries

MAXIMUM OPERATING CURRENT
 260 mA at 12 V, 130 mA at 24 V

MAXIMUM STANDBY CURRENT
 120 mA at 12 V, 65 mA at 24 V

CHARGE FAIL/EXCITATION RANGE
 0 V to 35 V

OUTPUTS
OUTPUT A (FUEL)
 15 A DC at supply voltage

OUTPUT B (START)
 15 A DC at supply voltage

OUTPUTS C & D
 8 A AC at 250 V AC (Volt free)

AUXILIARY OUTPUTS E, F, G, H, I & J
 2 A DC at supply voltage

GENERATOR
VOLTAGE RANGE
 15 V to 333 V AC (L-N)

FREQUENCY RANGE
 3.5 Hz to 75 Hz

MAINS (UTILITY) (DSE7420)
VOLTAGE RANGE
 15 V to 333 V AC (L-N)

FREQUENCY RANGE
 3.5 Hz to 75 Hz

BUS (DSE7410)
VOLTAGE RANGE
 15 V to 333 V AC (L-N)

FREQUENCY RANGE
 3.5 Hz to 75 Hz

MAGNETIC PICK UP
VOLTAGE RANGE
 +/- 0.5 V to 70 V

FREQUENCY RANGE
 10,000 Hz (max)

DIMENSIONS
OVERALL
 240 mm x 172 mm x 57 mm
 9.4" x 6.8" x 2.2"

PANEL CUTOUT
 220 mm x 160 mm
 8.7" x 6.3"

MAXIMUM PANEL THICKNESS
 8 mm
 0.3"

STORAGE TEMPERATURE RANGE
 -40°C to +85°C

DEEP SEA ELECTRONICS PLC UK

Highfield House, Hunmanby Industrial Estate, Hunmanby YO14 0PH
TELEPHONE +44 (0) 1723 890099 **FACSIMILE** +44 (0) 1723 893303
EMAIL sales@deepseapl.com **WEBSITE** www.deepseapl.com

DEEP SEA ELECTRONICS INC USA

3230 Williams Avenue, Rockford, IL 61101-2668 USA
TELEPHONE +1 (815) 316 8706 **FACSIMILE** +1 (815) 316 8708
EMAIL sales@deepseausa.com **WEBSITE** www.deepseausa.com

Molded Case Circuit Breakers
Power Defense™ UL Global Series
Part Number: PDG43G0800B2NJNNNNNN



Datasheet creation date: 20/11/2019

PRODUCT VIEW *(Use Mouse to Rotate and Zoom)*

Eaton's Power Defense™ molded case circuit breakers, a globally rated platform designed to help keep your power system safe with latest protection technology. Engineered for the future: IoT and Industry 4.0 features such as built-in communications, advanced energy metering, and algorithms that signal breaker maintenance; zone selective interlock technology that clears faults quickly and locally; ArcFlash reduction options that help protect your people, and not to mention Eaton's best-in-class support and service.

Tech Data for Configured Product

Power Defense Catalog Number	PDG43G0800B2NJNNNNNN
Frame Size	Frame 4
Poles	3 Pole
Voltage	240V AC
Interruption or Breaking Capacity (Icu/Ics)	55kA
Continuous Current Rating (In)	800A
Trip Unit Type	PXR10
Trip Unit Options 1	LSI
Trip Unit Options 2	None
Indicating Accessories	None
Indicating Accessories Terminal	None
Tripping Accessories	None
Tripping Accessory Terminal	None
Tripping Accessory Voltage	None
Line Type Description	Option 1 - Standard Terminal
Line Conductor Options	(3) 3/0 - 400
Line Terminal Type	Aluminum
Load Type Description	Option 1 - Standard Terminal
Load Conductor Options	(3) 3/0 - 400
Load Terminal Type	Aluminum
Special Options - Type of Modification	None
Details	None
Additional Description	None

Molded Case Circuit Breakers
Power Defense™ UL Global Series
Part Number: PDG43G0800B2NJNNNNNN

Technical drawings

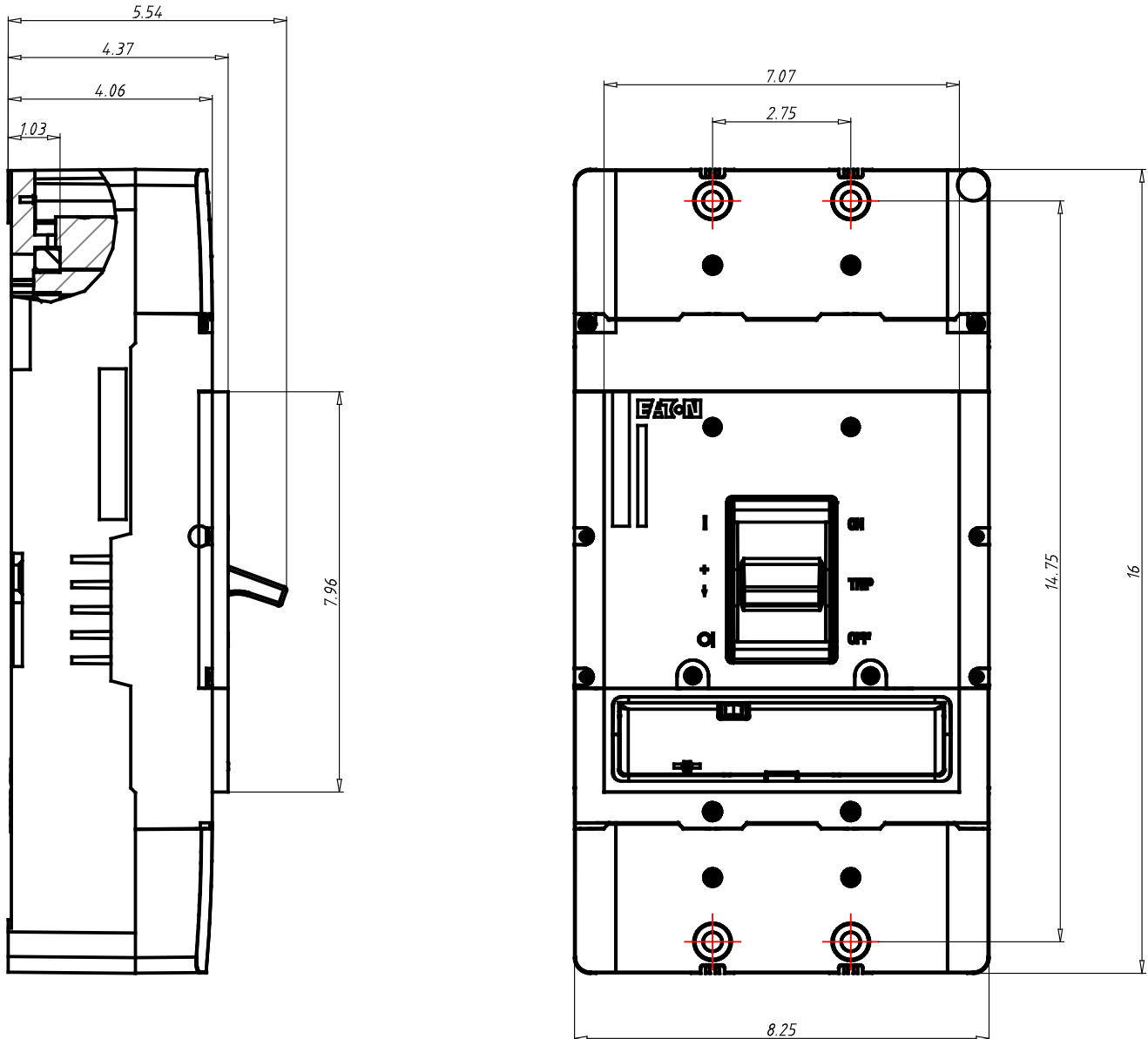

Molded Case Circuit Breakers
Power Defense™ UL Global Series
Part Number: PDG43G0800B2NJNNNNNN



Datasheet creation date: 20/11/2019

General Technical Data

Frame Rating (In)	800A
Reference Standard	UL489, CSA 22.2, IEC 60947-2 & GB
Number of poles	3
Neutral rating	-
Interruption Rating Designator	G / K / M
UL Interruption Rating to UL 489 (240Vac)	65 / 85 / 100kA
UL Interruption Rating to UL 489 (480Vac)	35 / 50 / 65(a)kA
UL Interruption Rating to UL 489 (600Vac)	18 / 25 / 35kA
UL Interruption Rating to UL 489 (125/250Vdc)	
UL Current Limiting	-
Rated breaking capacity to IEC 60947-2 (220-240 Vac Icu)	55 / 85 / 100 / 100kA
Rated breaking capacity to IEC 60947-2 (220-240 Vac Ics)	55 / 85 / 100 / 100kA
Rated breaking capacity to IEC 60947-2 (380-415 Vac Icu)	36 / 50 / 70 / 70kA
Rated breaking capacity to IEC 60947-2 (380-415 Vac Ics)	36 / 50 / 53 / 70kA
Rated breaking capacity to IEC 60947-2 (440 Vac Icu)	30 / 35 / 50 / 65kA
Rated breaking capacity to IEC 60947-2 (440 Vac Ics)	22.5 / 35 / 40 / 50kA
Rated breaking capacity to IEC 60947-2 (525 Vac Icu)	20 / 25 / 30 / 35kA
Rated breaking capacity to IEC 60947-2 (525 Vac Ics)	16.5 / 20 / 25 / 25kA
Rated breaking capacity to IEC 60947-2 (690 Vac Icu)	8 / 10 / 15 / 20kA
Rated breaking capacity to IEC 60947-2 (690 Vac Ics)	4 / 5 / 7.5 / 10kA
Rated breaking capacity to IEC 60947-2 (125V DC Icu)	
Rated breaking capacity to IEC 60947-2 (250V DC 2P in series Ics)	22 / 22 / 25kA
Frequency	50/60Hz
Trip Unit Type	PXR10
Continuous Current Range	320 - 800A
100% UL489 Rated	Yes
Instantaneous/Short Circuit Range	2 - 8 In
Magnetic/Instantaneous Override	6800A
Dimensions H x W x D (inches)	16 x 8.25 x 4.38
Pole to pole distance inches	2,75
Approx Weight lbs	29,98
RoHS Compliance	Yes
UL File Number	E7819
Ambient Temp Calibration	
Derating at 50C	
Derating at 60C	
Derating at 70C	

1. 480Vac corresponds to 277Vac for 1P
2. 600Vac corresponds to 347Vac for 1P

Molded Case Circuit Breakers
Power Defense™ UL Global Series
Part Number: PDG53K1200E3RNNNNNNN



Datasheet creation date: 19/08/2019

PRODUCT VIEW *(Use Mouse to Rotate and Zoom)*

Eaton's Power Defense™ molded case circuit breakers, a globally rated platform designed to help keep your power system safe with latest protection technology. Engineered for the future: IoT and Industry 4.0 features such as built-in communications, advanced energy metering, and algorithms that signal breaker maintenance; zone selective interlock technology that clears faults quickly and locally; ArcFlash reduction options that help protect your people, and not to mention Eaton's best-in-class support and service.

Tech Data for Configured Product

Power Defense Catalog Number	PDG53K1200E3RNNNNNNN
Frame Size	Frame 5
Poles	3 Pole
Voltage	480V AC
Interruption or Breaking Capacity (Icu/Ics)	50kA
Continuous Current Rating (In)	1200A
Trip Unit Type	PXR20
Trip Unit Options 1	LSIG
Trip Unit Options 2	Relays
Indicating Accessories	None
Indicating Accessories Terminal	None
Tripping Accessories	None
Tripping Accessory Terminal	None
Tripping Accessory Voltage	None
Line Type Description	None
Line Conductor Options	N/A
Line Terminal Type	N/A
Load Type Description	None
Load Conductor Options	N/A
Load Terminal Type	N/A
Special Options - Type of Modification	None
Details	None
Additional Description	None

Molded Case Circuit Breakers
Power Defense™ UL Global Series
Part Number: PDG53K1200E3RNNNNNN

Technical drawings

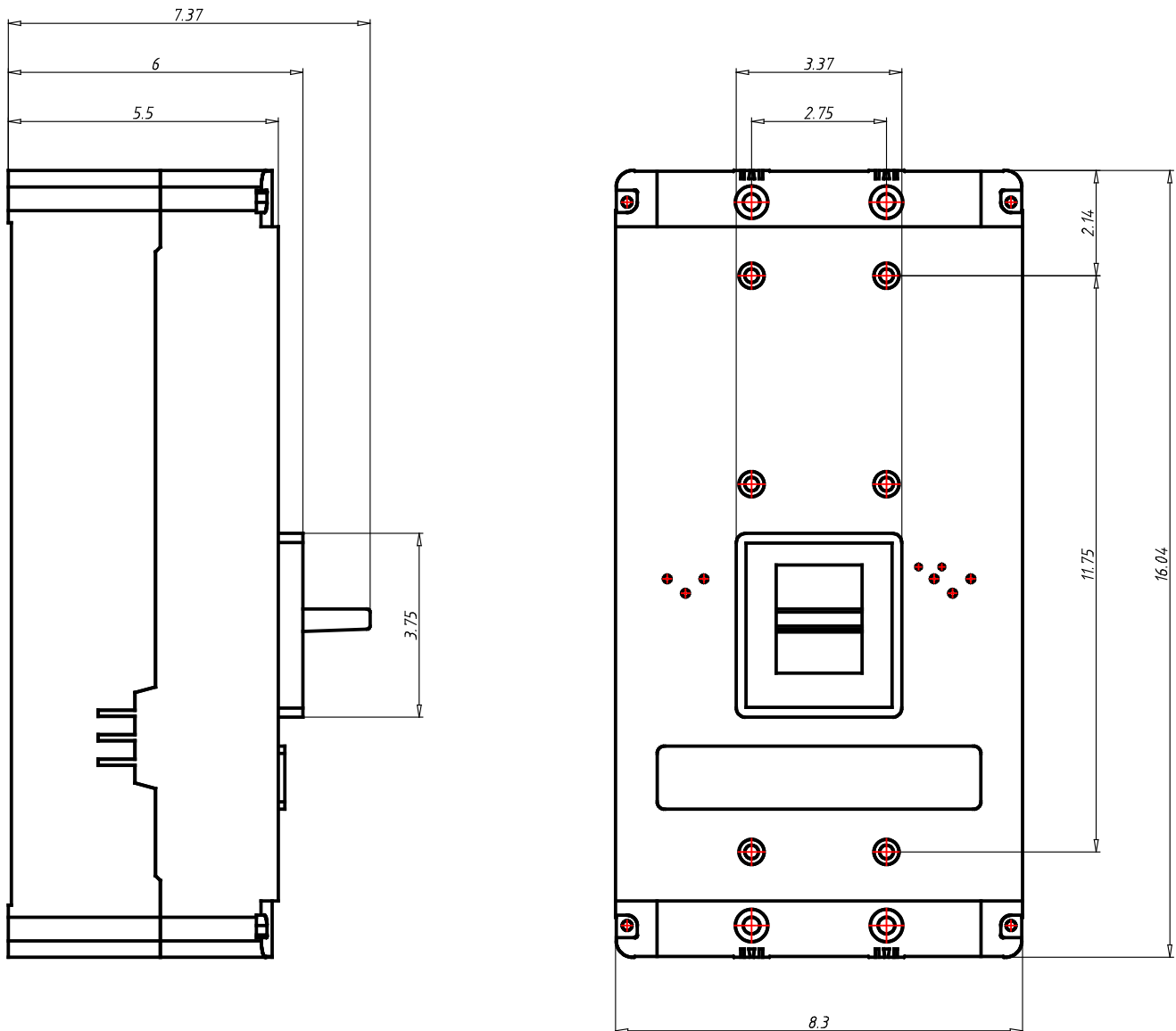

Molded Case Circuit Breakers
Power Defense™ UL Global Series
Part Number: PDG53K1200E3RNNNNNNN



Datasheet creation date: 19/08/2019

General Technical Data

Frame Rating (In)	1200A
Reference Standard	UL489, CSA 22.2, IEC 60947-2 & GB
Number of poles	3
Neutral rating	-
Interruption Rating Designator	K / M / N / P / T
UL Interruption Rating to UL 489 (240Vac)	85 / 100 / 150 / 200 / 200kA
UL Interruption Rating to UL 489 (480Vac)	50 / 65 / 85 / 100 / 150kA
UL Interruption Rating to UL 489 (600Vac)	25 / 35 / 50 / 65 / 65kA
UL Interruption Rating to UL 489 (125/250Vdc)	
UL Current Limiting	-
Rated breaking capacity to IEC 60947-2 (220-240 Vac Icu)	85 / 100 / 150 / 200kA
Rated breaking capacity to IEC 60947-2 (220-240 Vac Ics)	85 / 100 / 100 / 150kA
Rated breaking capacity to IEC 60947-2 (380-415 Vac Icu)	50 / 70 / 70 / 100kA
Rated breaking capacity to IEC 60947-2 (380-415 Vac Ics)	50 / 50 / 50 / 50kA
Rated breaking capacity to IEC 60947-2 (440 Vac Icu)	35 / 50 / 70 / 100kA
Rated breaking capacity to IEC 60947-2 (440 Vac Ics)	35 / 40 / 50 / 50kA
Rated breaking capacity to IEC 60947-2 (525 Vac Icu)	25 / 30 / 35 / 40kA
Rated breaking capacity to IEC 60947-2 (525 Vac Ics)	20 / 25 / 25 / 25kA
Rated breaking capacity to IEC 60947-2 (690 Vac Icu)	10 / 15 / 20 / 35kA
Rated breaking capacity to IEC 60947-2 (690 Vac Ics)	5 / 7.5 / 10 / 18kA
Rated breaking capacity to IEC 60947-2 (125V DC Icu)	
Rated breaking capacity to IEC 60947-2 (250V DC 2P in series Ics)	25
Frequency	50/60Hz
Trip Unit Type	PXR20
Continuous Current Range	500 - 1200A
100% UL489 Rated	Yes
Instantaneous/Short Circuit Range	2 - 10 In
Magnetic/Instantaneous Override	14400A
Dimensions H x W x D (inches)	16 x 8.25 x 5.5
Pole to pole distance inches	2,75
Approx Weight lbs	45
RoHS Compliance	Yes
UL File Number	E7819
Ambient Temp Calibration	
Derating at 50C	
Derating at 60C	
Derating at 70C	

1. 480Vac corresponds to 277Vac for 1P
2. 600Vac corresponds to 347Vac for 1P

Molded Case Circuit Breakers
Power Defense™ UL Global Series
Part Number: PDG63M2000E3RNNNNNNN



Datasheet creation date: 02/12/2019

PRODUCT VIEW *(Use Mouse to Rotate and Zoom)*

Eaton's Power Defense™ molded case circuit breakers, a globally rated platform designed to help keep your power system safe with latest protection technology. Engineered for the future: IoT and Industry 4.0 features such as built-in communications, advanced energy metering, and algorithms that signal breaker maintenance; zone selective interlock technology that clears faults quickly and locally; ArcFlash reduction options that help protect your people, and not to mention Eaton's best-in-class support and service.

Tech Data for Configured Product

Power Defense Catalog Number	PDG63M2000E3RNNNNNNN
Frame Size	Frame 6
Poles	3 Pole
Voltage	480V AC
Interruption or Breaking Capacity (Icu/Ics)	65kA
Continuous Current Rating (In)	2000A
Trip Unit Type	PXR20
Trip Unit Options 1	LSIG
Trip Unit Options 2	Relays
Indicating Accessories	None
Indicating Accessories Terminal	None
Tripping Accessories	None
Tripping Accessory Terminal	None
Tripping Accessory Voltage	None
Line Type Description	None
Line Conductor Options	N/A
Line Terminal Type	N/A
Load Type Description	None
Load Conductor Options	N/A
Load Terminal Type	N/A
Special Options - Type of Modification	None
Details	None
Additional Description	None

Molded Case Circuit Breakers
Power Defense™ UL Global Series
Part Number: PDG63M2000E3RNNNNNNN

Technical drawings

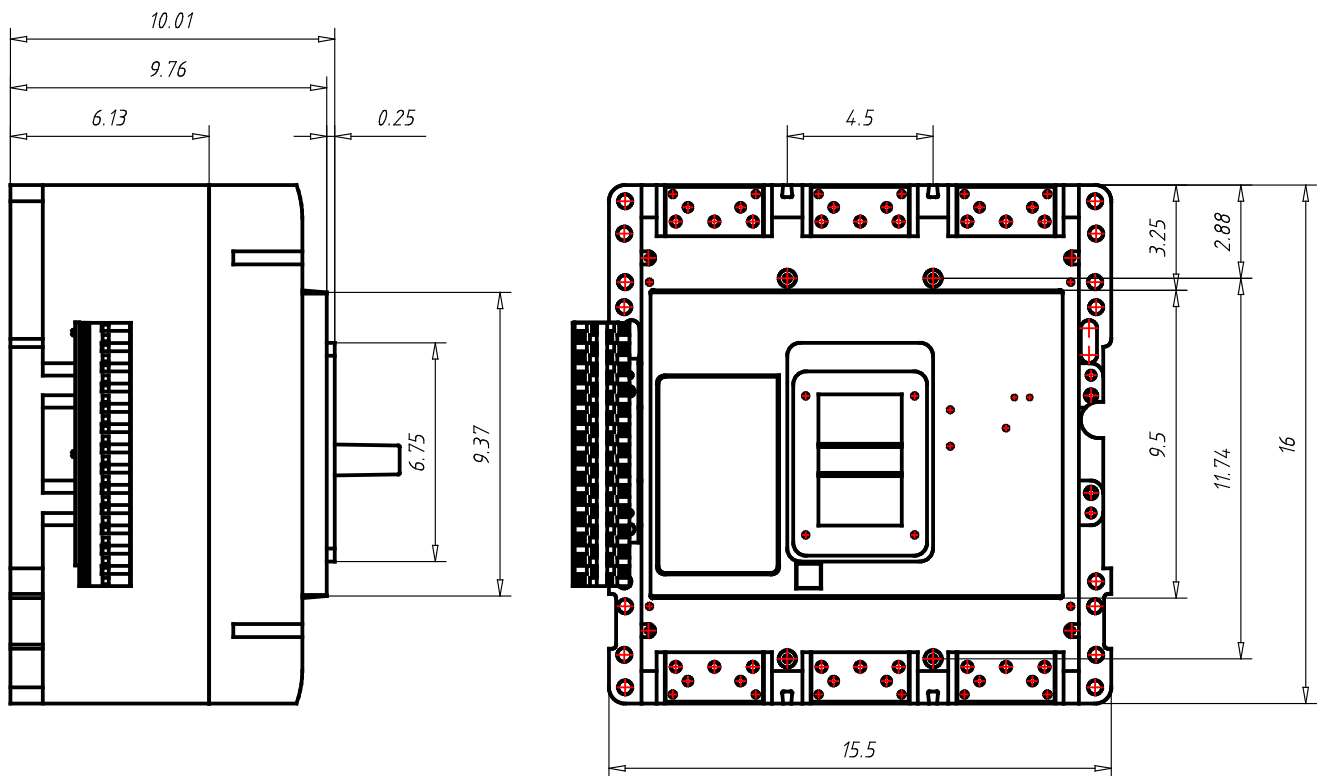

Molded Case Circuit Breakers
Power Defense™ UL Global Series
Part Number: PDG63M2000E3RNNNNNNN



Datasheet creation date: 02/12/2019

General Technical Data

Frame Rating (In)	2000A
Reference Standard	UL489, CSA 22.2, IEC 60947-2 & GB
Number of poles	3
Neutral rating	-
Interruption Rating Designator	M / N / P
UL Interruption Rating to UL 489 (240Vac)	125 / 150 / 200kA
UL Interruption Rating to UL 489 (480Vac)	65 / 85 / 100kA
UL Interruption Rating to UL 489 (600Vac)	35 / 50 / 65kA
UL Interruption Rating to UL 489 (125/250Vdc)	
UL Current Limiting	-
Rated breaking capacity to IEC 60947-2 (220-240 Vac Icu)	135 / 150 / 200kA
Rated breaking capacity to IEC 60947-2 (220-240 Vac Ics)	100 / 100 / 100kA
Rated breaking capacity to IEC 60947-2 (380-415 Vac Icu)	70 / 70 / 100kA
Rated breaking capacity to IEC 60947-2 (380-415 Vac Ics)	50 / 50 / 50kA
Rated breaking capacity to IEC 60947-2 (440 Vac Icu)	50 / 70 / 100kA
Rated breaking capacity to IEC 60947-2 (440 Vac Ics)	40 / 50 / 50kA
Rated breaking capacity to IEC 60947-2 (525 Vac Icu)	30 / 35 / 40kA
Rated breaking capacity to IEC 60947-2 (525 Vac Ics)	25 / 25 / 25kA
Rated breaking capacity to IEC 60947-2 (690 Vac Icu)	15 / 20 / 35kA
Rated breaking capacity to IEC 60947-2 (690 Vac Ics)	7.5 / 13 / 18kA
Rated breaking capacity to IEC 60947-2 (125V DC Icu)	
Rated breaking capacity to IEC 60947-2 (250V DC 2P in series Ics)	25
Frequency	50/60Hz
Trip Unit Type	PXR20
Continuous Current Range	Fixed
100% UL489 Rated	Yes
Instantaneous/Short Circuit Range	Adjustable
Magnetic/Instantaneous Override	17500A
Dimensions H x W x D (inches)	16 x 15.5 x 9.75
Pole to pole distance inches	4,5
Approx Weight lbs	135
RoHS Compliance	Yes
UL File Number	E7819
Ambient Temp Calibration	
Derating at 50C	
Derating at 60C	
Derating at 70C	

1. 480Vac corresponds to 277Vac for 1P
2. 600Vac corresponds to 347Vac for 1P

Molded Case Circuit Breakers
Power Defense™ UL Global Series
Part Number: PDG63M2500E3RNNNNNNN



Datasheet creation date: 02/12/2019

PRODUCT VIEW *(Use Mouse to Rotate and Zoom)*

Eaton's Power Defense™ molded case circuit breakers, a globally rated platform designed to help keep your power system safe with latest protection technology. Engineered for the future: IoT and Industry 4.0 features such as built-in communications, advanced energy metering, and algorithms that signal breaker maintenance; zone selective interlock technology that clears faults quickly and locally; ArcFlash reduction options that help protect your people, and not to mention Eaton's best-in-class support and service.

Tech Data for Configured Product

Power Defense Catalog Number	PDG63M2500E3RNNNNNNN
Frame Size	Frame 6
Poles	3 Pole
Voltage	480V AC
Interruption or Breaking Capacity (Icu/Ics)	65kA
Continuous Current Rating (In)	2500A
Trip Unit Type	PXR20
Trip Unit Options 1	LSIG
Trip Unit Options 2	Relays
Indicating Accessories	None
Indicating Accessories Terminal	None
Tripping Accessories	None
Tripping Accessory Terminal	None
Tripping Accessory Voltage	None
Line Type Description	None
Line Conductor Options	None
Line Terminal Type	N/A
Load Type Description	None
Load Conductor Options	None
Load Terminal Type	N/A
Special Options - Type of Modification	None
Details	None
Additional Description	None

Molded Case Circuit Breakers
Power Defense™ UL Global Series
Part Number: PDG63M2500E3RNNNNNNN

Technical drawings

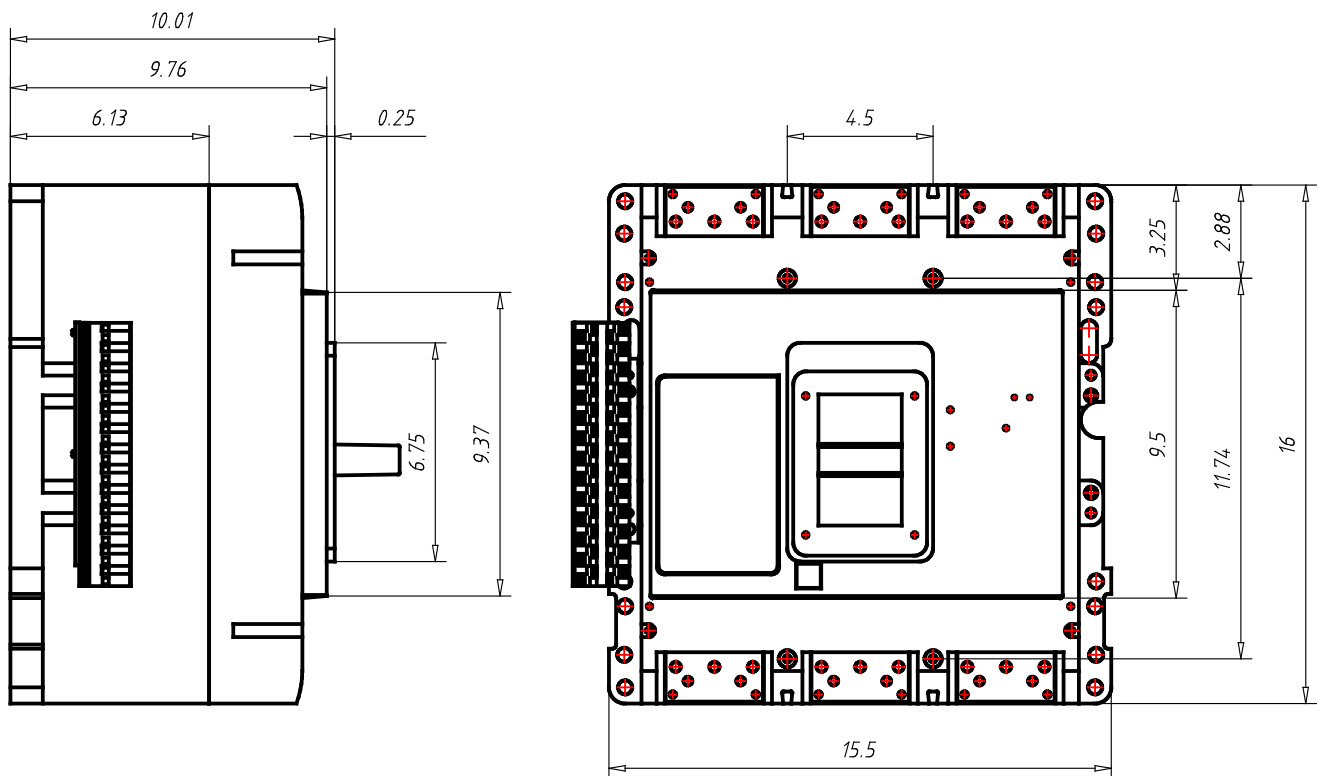

Molded Case Circuit Breakers
Power Defense™ UL Global Series
Part Number: PDG63M2500E3RNNNNNNN



Datasheet creation date: 02/12/2019

General Technical Data

Frame Rating (In)	2500A
Reference Standard	UL489, CSA 22.2, IEC 60947-2 & GB
Number of poles	3
Neutral rating	-
Interruption Rating Designator	M / N / P
UL Interruption Rating to UL 489 (240Vac)	125 / 150 / 200kA
UL Interruption Rating to UL 489 (480Vac)	65 / 85 / 100kA
UL Interruption Rating to UL 489 (600Vac)	35 / 50 / 65kA
UL Interruption Rating to UL 489 (125/250Vdc)	
UL Current Limiting	-
Rated breaking capacity to IEC 60947-2 (220-240 Vac Icu)	135 / 150 / 200kA
Rated breaking capacity to IEC 60947-2 (220-240 Vac Ics)	100 / 100 / 100kA
Rated breaking capacity to IEC 60947-2 (380-415 Vac Icu)	70 / 70 / 100kA
Rated breaking capacity to IEC 60947-2 (380-415 Vac Ics)	50 / 50 / 50kA
Rated breaking capacity to IEC 60947-2 (440 Vac Icu)	50 / 70 / 100kA
Rated breaking capacity to IEC 60947-2 (440 Vac Ics)	40 / 50 / 50kA
Rated breaking capacity to IEC 60947-2 (525 Vac Icu)	30 / 35 / 40kA
Rated breaking capacity to IEC 60947-2 (525 Vac Ics)	25 / 25 / 25kA
Rated breaking capacity to IEC 60947-2 (690 Vac Icu)	15 / 20 / 35kA
Rated breaking capacity to IEC 60947-2 (690 Vac Ics)	7.5 / 13 / 18kA
Rated breaking capacity to IEC 60947-2 (125V DC Icu)	
Rated breaking capacity to IEC 60947-2 (250V DC 2P in series Ics)	25
Frequency	50/60Hz
Trip Unit Type	PXR20
Continuous Current Range	Fixed
100% UL489 Rated	Yes
Instantaneous/Short Circuit Range	Adjustable
Magnetic/Instantaneous Override	17500A
Dimensions H x W x D (inches)	16 x 15.5 x 9.75
Pole to pole distance inches	4,5
Approx Weight lbs	135
RoHS Compliance	Yes
UL File Number	E7819
Ambient Temp Calibration	
Derating at 50C	
Derating at 60C	
Derating at 70C	

1. 480Vac corresponds to 277Vac for 1P
2. 600Vac corresponds to 347Vac for 1P

Main characteristics

The Tmax family, conforming to the UL 489 and CSA C22.2 No. 5.1 Standards, is enriched with the Tmax T8 size, which allows 3000 A to be reached. Also available in the 1600 A, 2000 A and 2500 A frames, Tmax T8 is equipped with the same electronic trip units as Tmax T7, thereby guaranteeing extremely high performances able to satisfy all installation requirements. Adequately sized for the performances offered (W=16.8 / D=11.2 / H=15.0 in). Tmax T8 is able to interrupt the following short-circuit currents: 125 kA@480 V and 100 kA@600 V.



Main characteristics

General characteristics

The Tmax T8 size has both circuit breakers and molded case switches (MCS). The following tables show the main characteristics of these ranges.

Circuit breakers for power distribution

			Tmax T8
Frame size	[A]		1600/2000/2500/3000
Number of poles	[No]		3/4
Rated voltage	(AC) 50-60 Hz	[V]	600
	(DC)	[V]	–
Test voltage (1 min) 50-60 Hz		[V]	3000
Interrupting ratings		[kA rms]	V
	240 V AC	[kA rms]	125
	480 V AC	[kA rms]	125
	600 V AC	[kA rms]	100
Trip units	Electronic	PR232/P-T8	■
		PR331/P	■
		PR332/P	■
Dimensions fixed version (3p)	H	[in-mm]	15.0 - 382
	W	[in-mm]	16.8 - 427
	D	[in-mm]	11.2 - 282
Mechanical life		[operations]	15000
Weight (fixed 3p)	1600/2000/2500 A	[lbs]	161
	3000 A	[lbs]	236

Molded case switches (MCS)

The Tmax T8 MCS are derived from the corresponding circuit breakers, of which they keep the overall dimensions, the versions, the fixing systems and the possibility of mounting accessories unchanged. This version only differs from the circuit breakers in the absence of the protection trip units. All molded case switches comply with the UL 489 and CSA C22.2 Standards and are self-protected.

			Tmax T8V-D
Rating	[A]		2000/2500/3000
Poles	[No]		3/4
Magnetic override		[A]	40000
Rated voltage	AC (50-60 Hz)	[V]	600
	DC	[V]	–

NRG

Intelligent Engine Start Battery Charger



The Smart Choice for Mission-Critical Engine Starting

- Fast, accurate, mission-critical charging – gives best starting reliability
- 4-rate, temperature-compensated output – offers longest battery life
- Replace nearly any charger – without planning ahead
- Industry-first battery-fault alarm – helps dispatch service early
- Lasting reliability – field MTBF > 1 million hours with industry-best warranty
- IBC seismic certification – meets latest building codes, no installation delays
- Optional OSHPD pre-approval – already approved for California hospital projects



NRG Battery Charger Benefits and Features



Failure to start due to battery problems is the leading cause of inoperable engine generator sets.

SENS NRG battery charger maximizes starting system reliability while slashing genset servicing costs:

One NRG replaces almost any charger without extra site visits. Installers can select or change at any time 120, 208 or 240 volts AC input, 12 or 24-volt battery and output settings optimized for nearly any lead-acid or nickel cadmium battery.

Easy to understand user interface provides state-of-the-art system status – including digital metering, NFPA 110 alarms and a battery fault alarm that can send service personnel to the site before failure to start.

Batteries charged by NRG give higher performance and last longer. In uncontrolled environments precision charging by SENS increases battery life and watering intervals 400% or more.

NRG meets all relevant industry standards – including UL, NFPA 110 and CE. Seismic Certification per International Building Code (IBC) 2000, 2003, 2006. All units are C-UL listed. 50/60 Hz units add CE marking to UL agency marks.

EnerGenius reliability technology built into every charger includes:

- All-electronic operation with generous component de-rating
- Disconnected/reversed/incorrect voltage battery alarm and protection
- Protection of connected equipment against load dump transients
- Widest temperature rating, and overtemperature protection
- Superior lightning and voltage transient protection
- Demonstrated field MTBF > 1 million hours
- Standard 3-year warranty (10 years magnetics and power semiconductors) and available 10-year extended warranty

Earn the best return on your charger investment – choose SENS NRG

NRG Specifications

AC Input

Voltage	110-120/208-240 VAC, $\pm 10\%$, single phase, field selectable
Input current	10A charger: 6.6/3.3 amps maximum 20A charger: 12.6/6.3 amps maximum
Frequency	60 Hz $\pm 5\%$ standard; 50/60 Hz $\pm 5\%$ optional
Input protection	1-pole fuse, soft-start, transient suppression

Charger Output

Nominal voltage ratings	12 or 24 volt nominal
Optional voltage rating	12/24 volt, field selectable
Battery settings	Six discrete battery voltage programs - Low or high S.G. flooded - Low or high S.G. VRLA - Nickel cadmium 9, 10, 18, 19 or 20 cells
Regulation	$\pm 0.5\%$ (1/2%) line and load regulation
Current	10 or 20 amps nominal
Electronic current limit	105% rated output typical – no crank disconnect required
Charge characteristic	Constant voltage, current limited, 4-rate automatic equalization
Temperature compensation	Enable or disable anytime, remote sensor optional
Output protection	Current limit, 1-pole fuse, transient suppression

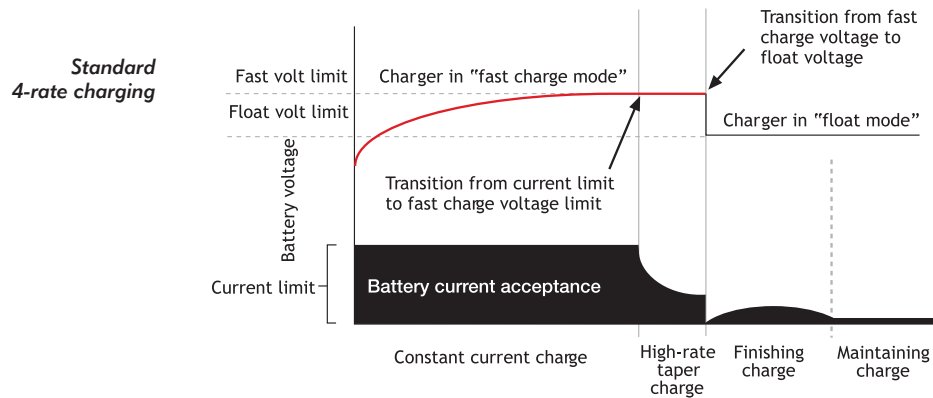

User Interface, Indication and Alarms

Digital meter	Automatic meter alternately displays output volts, amps ¹
Accuracy	$\pm 2\%$ volts, $\pm 5\%$ amps
Alarms	LED and Form C contact(s) per table:



Front panel status display

Alarm System Functions

Alarm code "C" (meets requirements of NFPA 110)	
AC good	LED
Float mode	LED
Fast charge	LED
Temp comp active	LED
AC fail	LED and Form C contact ²
Low battery volts	LED and Form C contact ²
High battery volts	LED and Form C contact ²
Charger fail	LED and Form C contact ²
Battery fault ³	LED and Form C contact ²

- Three-position jumper allows user to select from three display settings: alternating volts / amps (normal), constant volts, or constant amps
- Contacts rated 2A @ 30 VDC resistive
- Battery fault alarm indicates these fault conditions:
 - Battery disconnected - Battery polarity reversed - Mismatched charger battery voltage - Open or high resistance charger to battery connection
 - Open battery cell or excessive internal resistance

Controls

AC input voltage select
Optional 12/24-volt output select
Battery program select
Meter display select
Fast charger enable/disable
Temp compensation enable
Remote temp comp enable

Field-selectable switch
Field-selectable two-position jumper
Field-selectable six-position jumper
Field-selectable three-position jumper
Field-selectable two-position jumper
Standard. Can be disabled or re-enabled in the field
Connect optional remote sensor to temp comp port



Simple field adjustments

Environmental

Operating temperature
Over temperature protection
Humidity
Vibration (10A unit)
Transient immunity
Seismic Certification

-20C to +60C, meets full specification to +45C
Gradual current reduction to maintain safe power device temperature
5% to 95%, non-condensing
UL 991 Class B (2G sinusoidal)
ANSI/IEEE C62.41, Cat. B, EN50082-2 heavy industrial, EN 61000-6-2
IBC 2000, 2003, 2006, 2009 Maximum S_{ds} of 2.28 g, Optional OSHPD pre-approval

Agency Standards

Safety

Agency marking

EMC

NFPA standards
Optional agency compliance

C-UL listed to UL 1236 (required for UL 2200 gensets), UL Category BBGQ, CSA standard 22.2 no. 107.2-M89
CE: 50/60 Hz units DOC to EN 60335
60 Hz: C-UL-US listed
50/60 Hz: C-UL-US listed plus CE marked
Emissions: FCC Part 15, Class B; EN 50081-2
Immunity: EN 61000-6-2
NFPA 70, NFPA 110. (NFPA 110 requires Alarms "C")
OSHPD pre-approval

Construction

Housing/configuration
Dimensions
Printed circuit card
Cooling
Protection degree
Damage prevention
Electrical connections

Material: Non-corroding aluminum. C-UL listed enclosure.
See Drawings and Dimensions page for details
Surface mount technology, conformal coated
Natural convection
Listed housing: NEMA-1 (IP20). Optional IP21 drip shield. Optional NEMA 3R enclosure
Fully recessed display and controls
Compression terminal blocks

Warranty

Standard warranty

Optional warranty

Three year parts and labor warranty (10 years magnetics and power semiconductors) from date of shipment
If specified at time of order, warranty coverage for the standard warranty period can be upgraded to reimburse customer's documented field service costs up to the original charger price. Alternatively, standard parts and labor warranty coverage can be increased to 5 or 10 years. Contact the factory for full details

Optional features

Input
Remote temp comp sensor
Drip shield meets s/b (IP21)
NEMA 3R housing

Input frequency, 50/60 Hz
Recommended where battery and charger are in different locations
Protects from dripping water
Enables outdoor installation (remote temp sensor recommended)

Drawings and Dimensions

10A Chargers

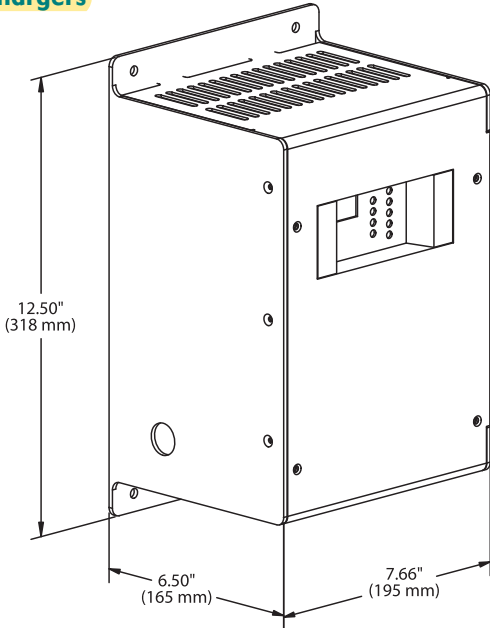

20A Chargers

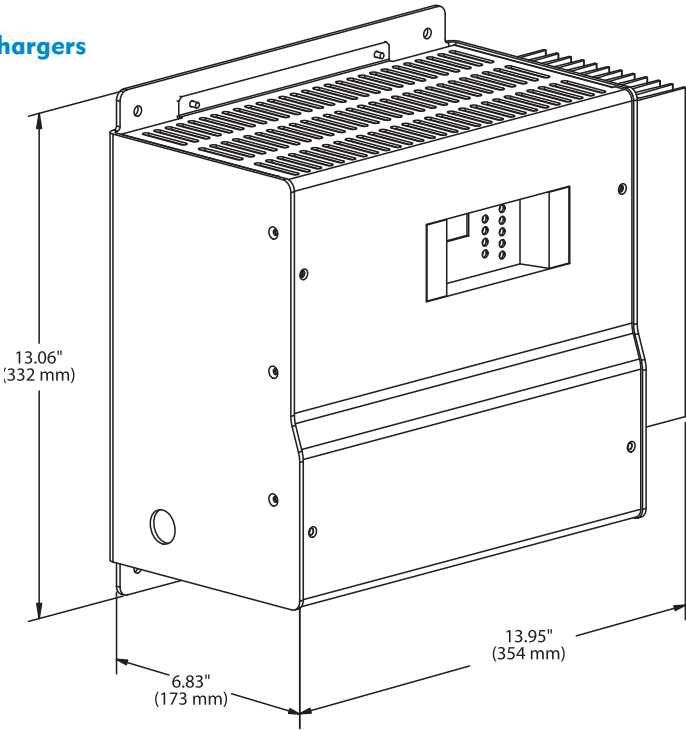

Housing Dimensions Table			
Amps	Width	Depth	Height
10	7.66" (195 mm)	6.50" (165 mm)	12.50" (318 mm)
20	13.95" (354 mm)	6.83" (173 mm)	13.06" (332 mm)

NRG Ordering Information

Output volts	Output amps	Model	NFPA 110 Alarms	Lbs/Kg	Shipping Lbs/Kg
12	10	NRG12-10-RC	Yes	23 / 10.4	25 / 11.4
24	10	NRG24-10-RC	Yes	23 / 10.4	25 / 11.4
12/24	10	NRG22-10-RC	Yes	23 / 10.4	25 / 11.4
12	20	NRG12-20-RC	Yes	39 / 17.7	43 / 19.5
24	20	NRG24-20-RC	Yes	42 / 19.1	46 / 20.9
12/24	20	NRG22-20-RC	Yes	42 / 19.1	46 / 20.9

All models offer field-selectable input 120/208-240 volts. 60 Hz input is standard with C-UL listing. Optional 50/60 Hz input includes C-UL listing and adds CE mark.

Model Number Breakout - 10 Amp Models



Model
Output voltage
 12: 12 volts
 24: 24 volts
 22: 12/24-volt
 field selectable

AC input
 R: 120/208-240 VAC, 60 Hz
 H: 120/208-240 VAC, 50/60 Hz

Option code
 E: OSHPD Pre-Approved

All NRG models are
 C-UL Listed to UL1236

All NRG models provide
 LEDs and Form C contacts
 to meet NFPA 110

Model Number Breakout - 20 Amp Models



Model
Output voltage
 12: 12 volts
 24: 24 volts
 22: 12/24-volt
 field selectable

AC input
 R: 120/208-240 VAC, 60 Hz
 H: 120/208-240 VAC, 50/60 Hz

Option code
 E: OSHPD Pre-Approved

The Smart Choice for Mission-Critical Engine Starting

Additional Information

Contact SENS or your local sales representative for additional specification, engineering and installation information. Check the SENS web site for latest available data. Specification is subject to change without notice.



Contact Information

For information and service on any SENS product, please contact us at:
 Sales 1.866.736.7872 • 303.678.7500 • Fax 303.678.7504
 www.sens-usa.com • info@sens-usa.com
 1840 Industrial Circle, Longmont, CO 80501 USA



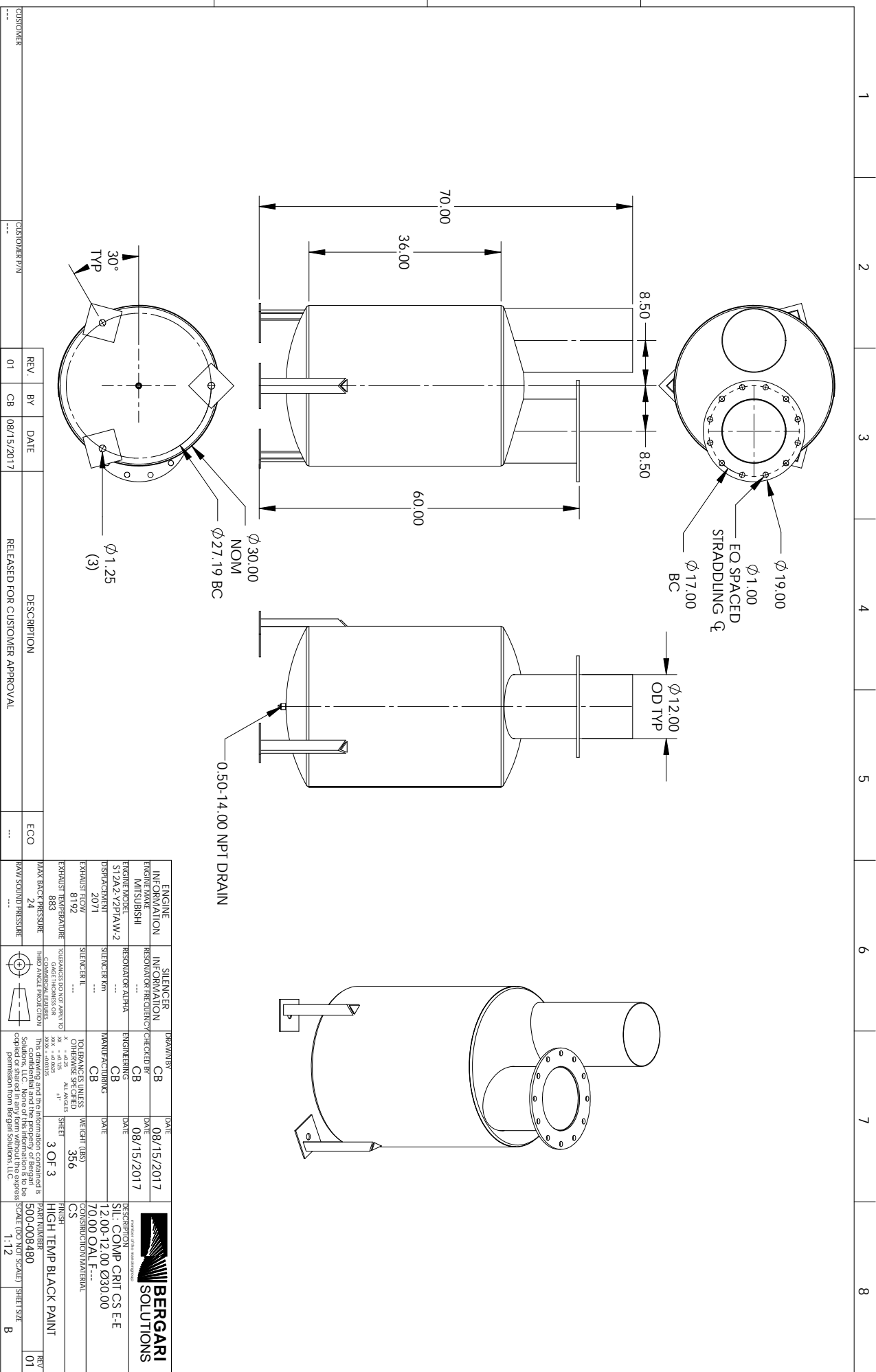

CUSTOMER	CUSTOMER/P/N	REV.	BY	DATE	DESCRIPTION	ECO
...	...	01	CB	08/15/2017	RELEASED FOR CUSTOMER APPROVAL	...

ENGINE INFORMATION	SILENCER INFORMATION	DRAWN BY	DATE
ENGINE MAKE: MITSUBISHI	RESONATOR FREQUENCY: ...	CHECKED BY: CB	08/15/2017
ENGINE MODEL: S12A2-YZP/AW-2	RESONATOR ALPHA: ...	ENGINEERING: CB	08/15/2017
DISTANCE: 2071	SILENCER Km: ...	MANUFACTURING: CB	DATE: ...
EXHAUST FLOW: 8192	SILENCER TL: ...	DATE: ...	DATE: ...
EXHAUST TEMPERATURE: 883	TOLERANCES TO BE ADHERED TO: ...	TOLERANCES TO BE ADHERED TO: ...	WEIGHT (LBS): 356
MAX BACK PRESSURE: 24	THIRD ANGLE PROJECTION: ...	DATE: ...	FINISH: HIGH TEMP BLACK PAINT
RAW SOUND PRESSURE: ...	COMMERCIAL LEADERS: ...	DATE: ...	PART NUMBER: 500-008480
...	SCALE (DO NOT SCALE): 1:1.2

BERGARI SOLUTIONS
 DESCRIPTION: SIL - COMP CRIT CS E-E
 12.00-12.00 Ø30.00
 70.00 OAL F...
 CONSTRUCTION MATERIAL: CS
 FINISH: HIGH TEMP BLACK PAINT
 PART NUMBER: 500-008480
 SCALE (DO NOT SCALE): 1:1.2
 SHEET SIDE: B
 REV: 01

LEVEL 2 & 3 ENCLOSURE OUTLINE DIMENSIONS FOR SP-6500 & SP-8000

TOP VIEW

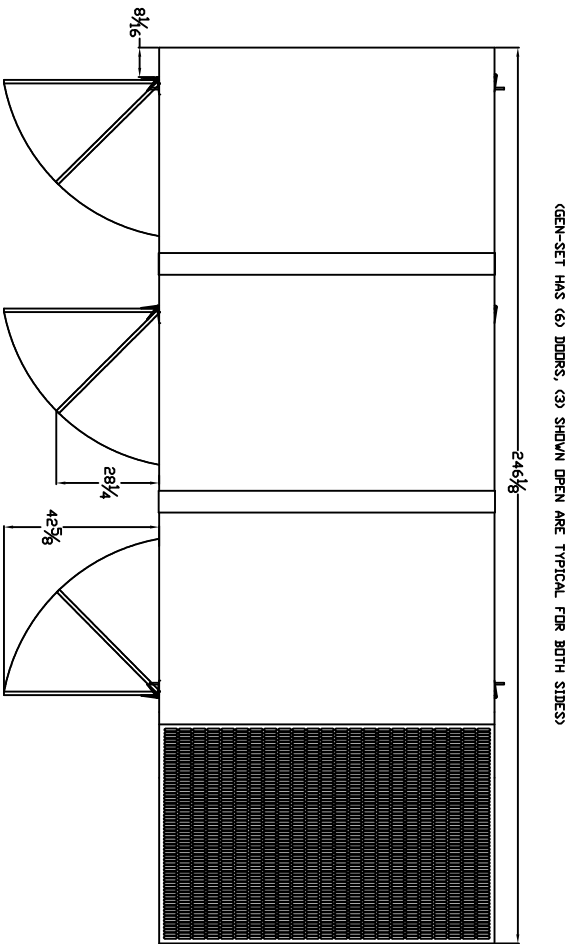

FRAME VIEW

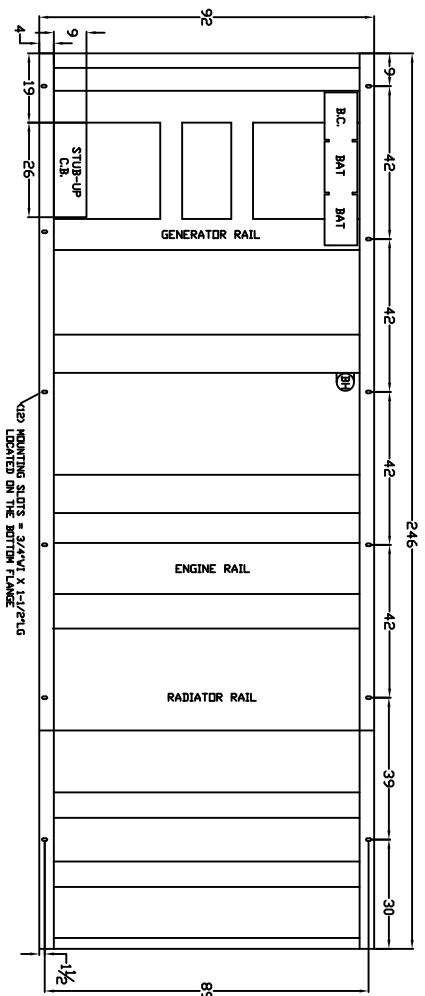

GENERATOR END VIEW

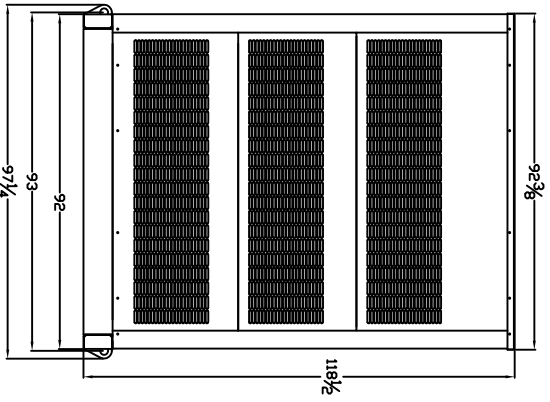

SIDE VIEW

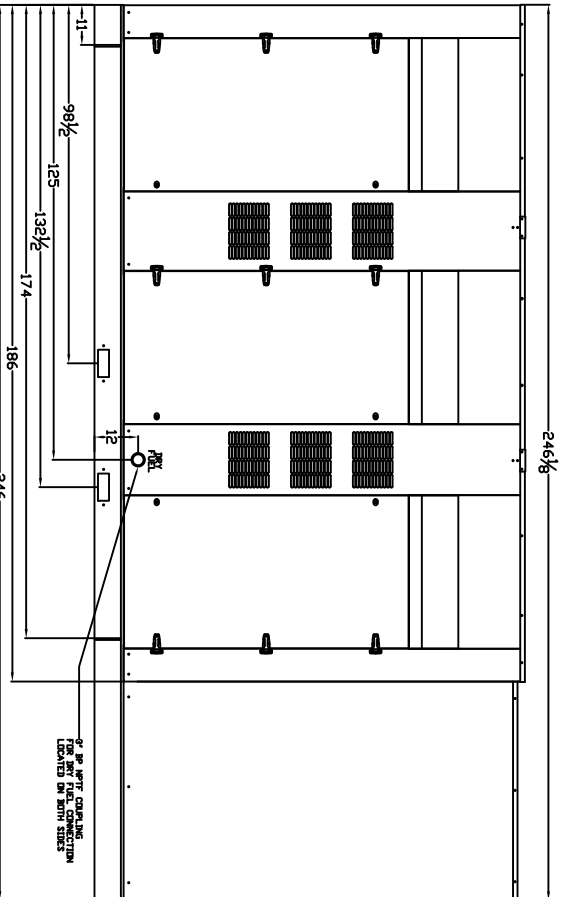

RADIATOR END VIEW

